

1MBI300N-120

IGBT Module

1200V / 300A 1 in one-package

■ Features

- High speed switching
- Voltage drive
- Low inductance module structure

■ Applications

- Inverter for Motor drive
- AC and DC Servo drive amplifier
- Uninterruptible power supply
- Industrial machines, such as Welding machines



■ Maximum ratings and characteristics

● Absolute maximum ratings (at $T_c=25^\circ\text{C}$ unless otherwise specified)

Item	Symbol	Rating	Unit
Collector-Emitter voltage	V_{CES}	1200	V
Gate-Emitter voltage	V_{GES}	± 20	V
Collector current	Continuous	I_c	300 A
	1ms	I_c pulse	600 A
	Continuous	$-I_c$	300 A
	1ms	$-I_c$ pulse	600 A
Max. power dissipation	P_c	2100	W
Operating temperature	T_j	+150	$^\circ\text{C}$
Storage temperature	T_{stg}	-40 to +125	$^\circ\text{C}$
Isolation voltage	V_{is}	AC 2500 (1min.)	V
Screw torque	Mounting *1	3.5	N·m
	Terminals *2	4.5	N·m
	Terminals *3	1.7	N·m

*1 : Recommendable value : 2.5 to 3.5 N·m(M5) or (M6)

*2 : Recommendable value : 3.5 to 4.5 N·m(M6)

*3 : Recommendable value : 1.3 to 1.7 N·m(M4)

■ Equivalent Circuit Schematic

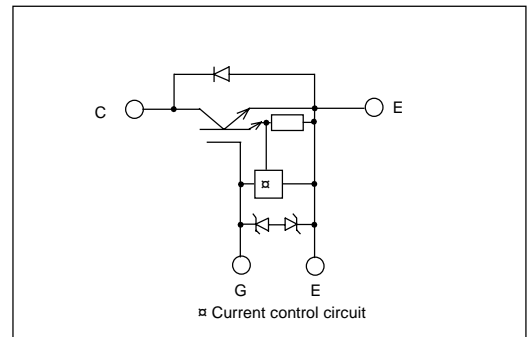

● Electrical characteristics (at $T_j=25^\circ\text{C}$ unless otherwise specified)

Item	Symbol	Characteristics			Conditions	Unit
		Min.	Typ.	Max.		
Zero gate voltage collector current	I_{CES}	—	—	4.0	$V_{GE}=0V, V_{CE}=1200V$	mA
Gate-Emitter leakage current	I_{GES}	—	—	60	$V_{CE}=0V, V_{GE}=\pm 20V$	μA
Gate-Emitter threshold voltage	$V_{GE(th)}$	4.5	—	7.5	$V_{CE}=20V, I_c=300\text{mA}$	V
Collector-Emitter saturation voltage	$V_{CE(sat)}$	—	—	3.3	$V_{GE}=15V, I_c=300A$	V
Input capacitance	C_{ies}	—	48000	—	$V_{GE}=0V$	pF
Output capacitance	C_{oes}	—	17400	—	$V_{CE}=10V$	
Reverse transfer capacitance	C_{res}	—	15480	—	$f=1\text{MHz}$	
Turn-on time	t_{on}	—	0.65	1.2	$V_{CC}=600V$	μs
	t_r	—	0.25	0.6	$I_c=300A$	
Turn-off time	t_{off}	—	0.95	1.5	$V_{GE}=\pm 15V$	μs
	t_f	—	0.35	0.5	$R_G=2.7\text{ohm}$	
Diode forward on voltage	V_F	—	—	3.0	$I_F=300A, V_{GE}=0V$	V
Reverse recovery time	t_{rr}	—	—	0.35	$I_F=300A$	μs

● Thermal resistance characteristics

Item	Symbol	Characteristics			Conditions	Unit
		Min.	Typ.	Max.		
Thermal resistance	$R_{th(j-c)}$	—	—	0.06	IGBT	$^\circ\text{C/W}$
	$R_{th(j-c)}$	—	—	0.17	Diode	$^\circ\text{C/W}$
	$R_{th(c-f)*4}$	—	0.0125	—	the base to cooling fin	$^\circ\text{C/W}$

*4 : This is the value which is defined mounting on the additional cooling fin with thermal compound

Characteristics (Representative)

Collector current vs. Collector-Emitter voltage
T_J=25°C

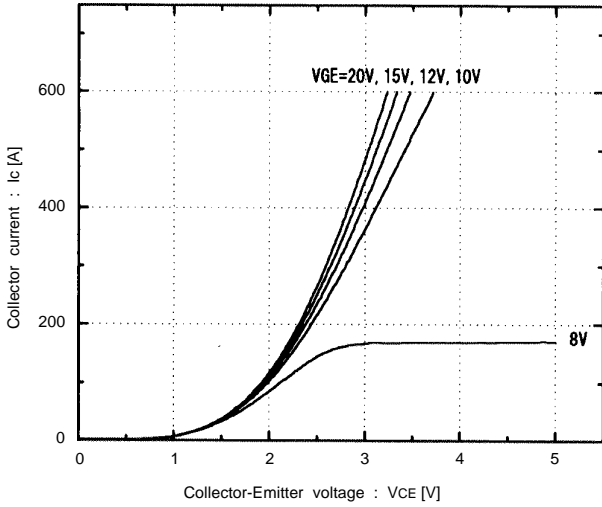

Collector current vs. Collector-Emitter voltage
T_J=125°C

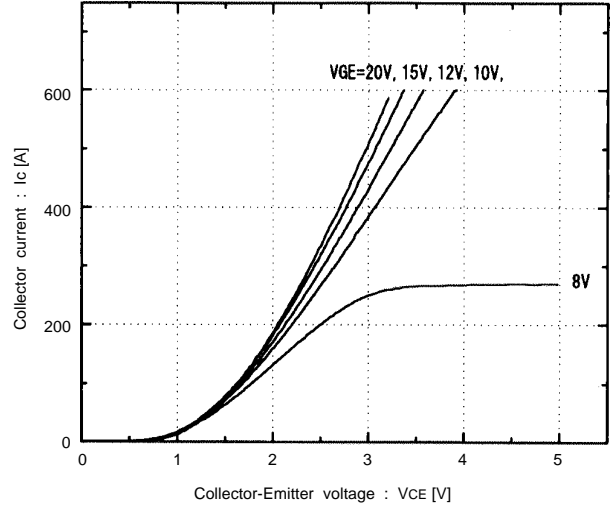

Collector-Emitter vs. Gate-Emitter voltage
T_J=25°C

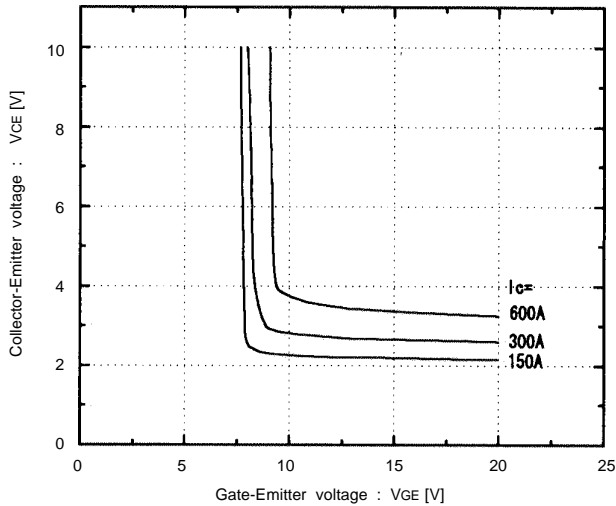

Collector-Emitter vs. Gate-Emitter voltage
T_J=125°C

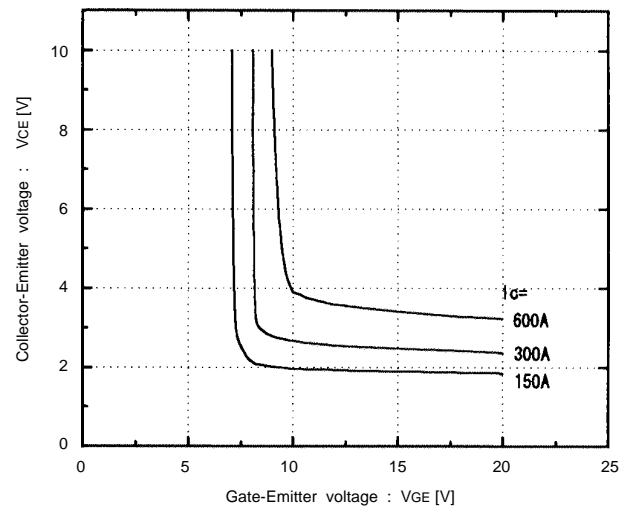

Switching time vs. Collector current
V_{CC}=600V, R_G=2.7 ohm, V_{GE}=±15V, T_J=25°C

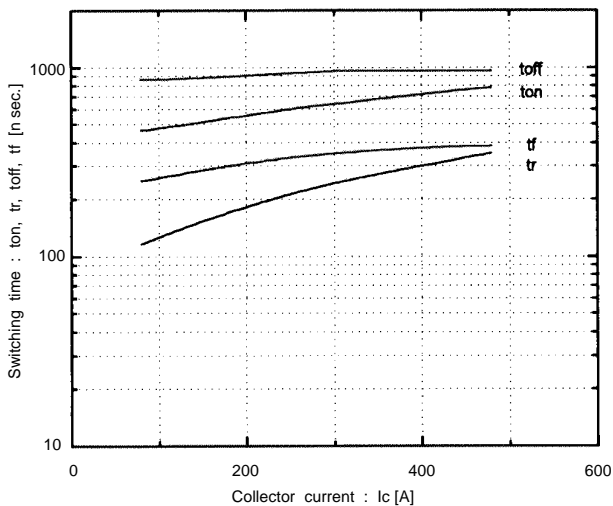

Switching time vs. Collector current
V_{CC}=600V, R_G=2.7 ohm, V_{GE}=±15V, T_J=125°C

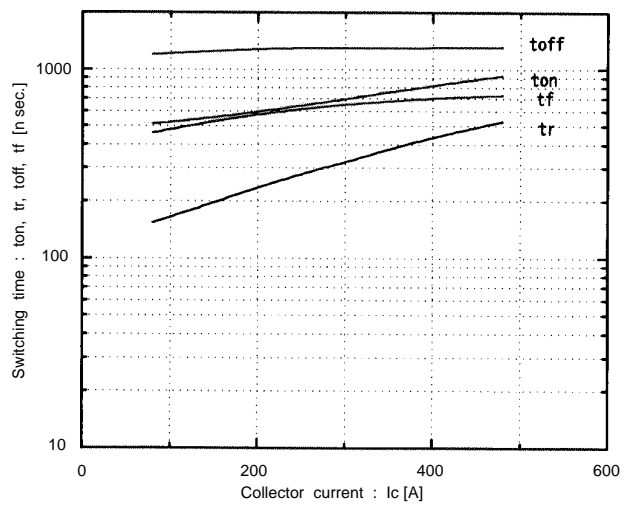

Switching time vs. R_G
 $V_{CC}=600V, I_c=300A, V_{GE}=\pm 15V, T_j=25^\circ C$

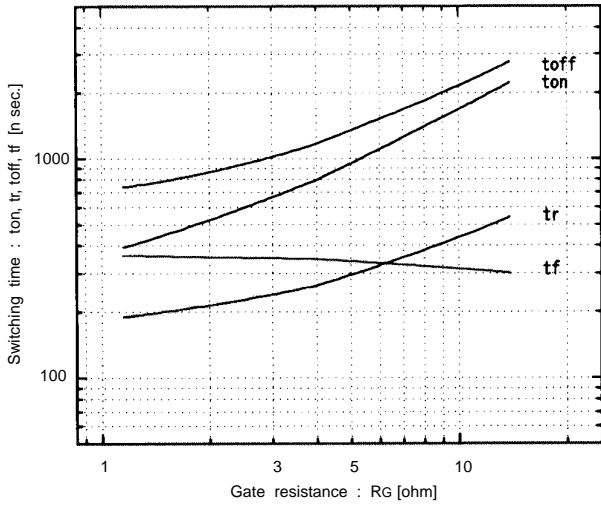

Dynamic input characteristics
 $T_j=25^\circ C$

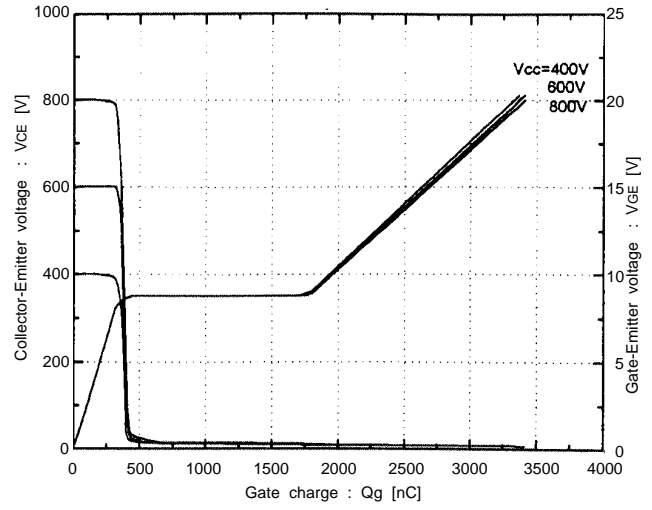

Forward current vs. Forward voltage
 $V_{GE}=0V$

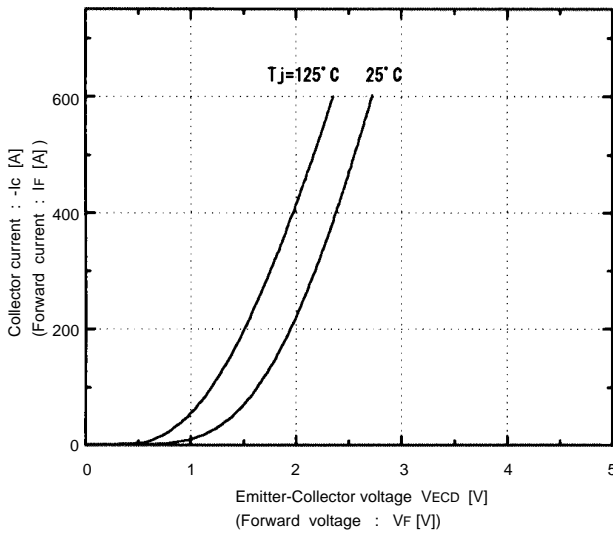

Reverse recovery characteristics
 t_{rr}, I_{rr} , vs. I_F

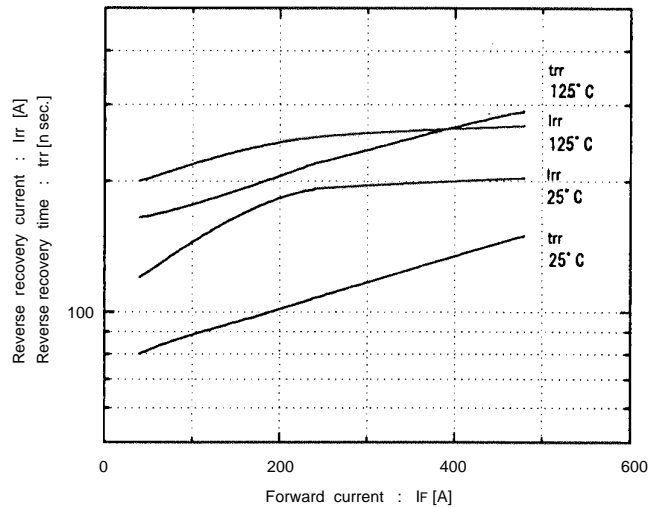

Switching loss vs. Collector current
 $V_{CC}=600V, R_G=2.7 \text{ ohm}, V_{GE}=\pm 15V$

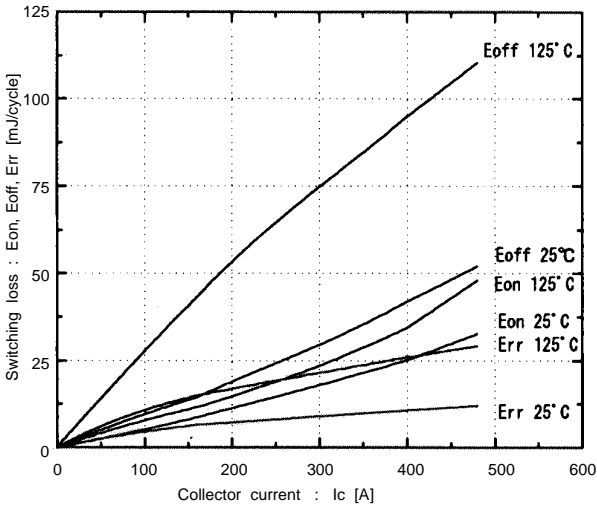

Reversed biased safe operating area
 $+V_{GE}=15V, -V_{GE} \leq 15V, T_j \leq 125^\circ C, R_G \geq 2.7 \text{ ohm}$

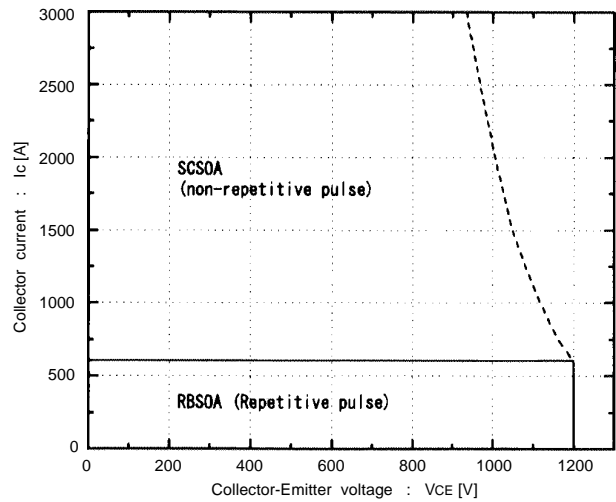

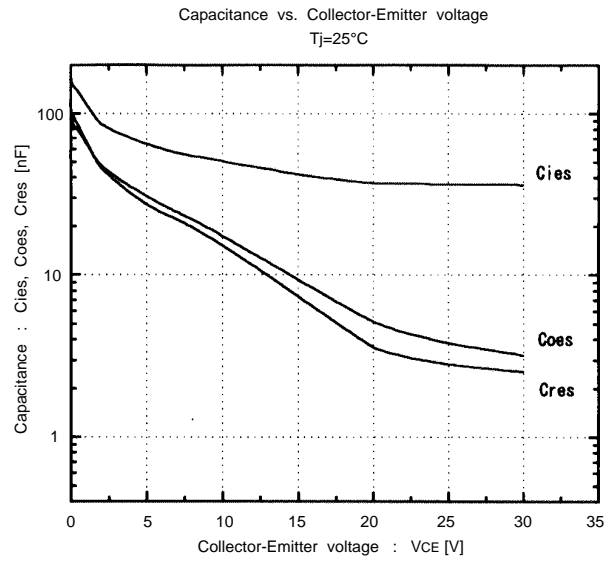
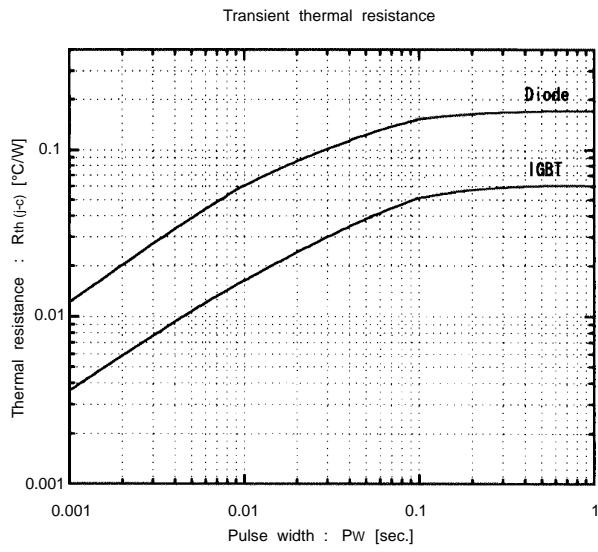

■ Outline Drawings, mm

