

# Kingbright®

## 14mm (0.56INCH) THREE DIGIT NUMERIC DISPLAYS

BA56-11	BC56-11
BA56-12	BC56-12
BA56-13	BC56-13

### Features

- 0.56 INCH DIGIT HEIGHT.
- LOW CURRENT OPERATION.
- EXCELLENT CHARACTER APPEARANCE.
- EASY MOUNTING ON P.C. BOARDS OR SOCKETS.
- I.C. COMPATIBLE.
- CATEGORIZED FOR LUMINOUS INTENSITY, YELLOW AND GREEN CATEGORIZED FOR COLOR.
- MECHANICALLY RUGGED.
- STANDARD : GRAY FACE, WHITE SEGMENT.

### Description

The Bright Red source color devices are made with Gallium Phosphide Red Light Emitting Diode.

The Green source color devices are made with Gallium Phosphide Green Light Emitting Diode.

The High Efficiency Red source color devices are made with Gallium Arsenide Phosphide on Gallium Phosphide Orange Light Emitting Diode.

The Yellow source color devices are made with Gallium Arsenide Phosphide on Gallium Phosphide Yellow Light Emitting Diode.

The Super Bright Red source color devices are made with Gallium Aluminum Arsenide Red Light Emitting Diode.

### Package Dimensions

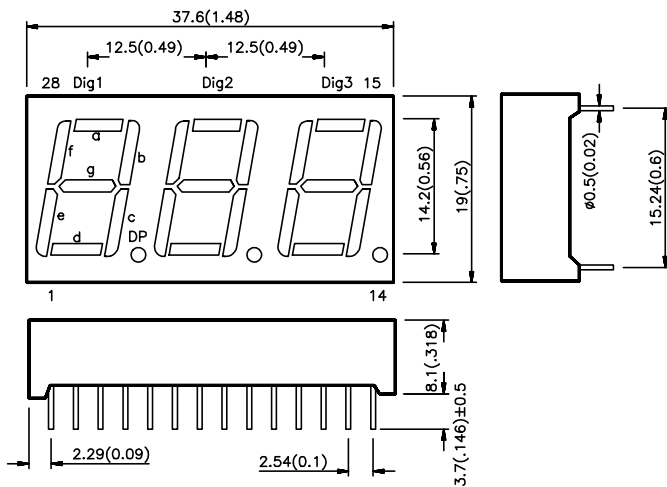

### Internal Circuit Diagram

#### BA56-11

COMMON ANODE

Dig1 : 3,26  
Dig2 : 19  
Dig3 : 18

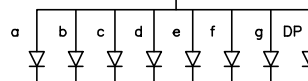

Dig1: 25 24 4 2 1 27 28 5  
Dig2: 21 20 8 7 6 23 22 9  
Dig3: 16 15 13 11 10 17 12 14

#### BC56-11

COMMON CATHODE

Dig1 : 3,26  
Dig2 : 19  
Dig3 : 18

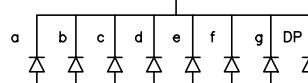

Dig1: 25 24 4 2 1 27 28 5  
Dig2: 21 20 8 7 6 23 22 9  
Dig3: 16 15 13 11 10 17 12 14

#### BA56-13

COMMON ANODE

Dig1 : 26  
Dig2 : 8,21  
Dig3 : 15

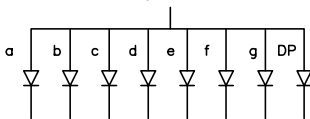

Dig1: 27 24 3 2 1 28 25 4  
Dig2: 22 19 7 6 5 23 20 9  
Dig3: 16 14 12 11 10 17 18 13

#### BC56-13

COMMON CATHODE

Dig1 : 26  
Dig2 : 8,21  
Dig3 : 15

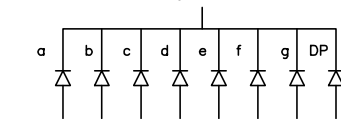

Dig1: 27 24 3 2 1 28 25 4  
Dig2: 22 19 7 6 5 23 20 9  
Dig3: 16 14 12 11 10 17 18 13

Package Dimensions

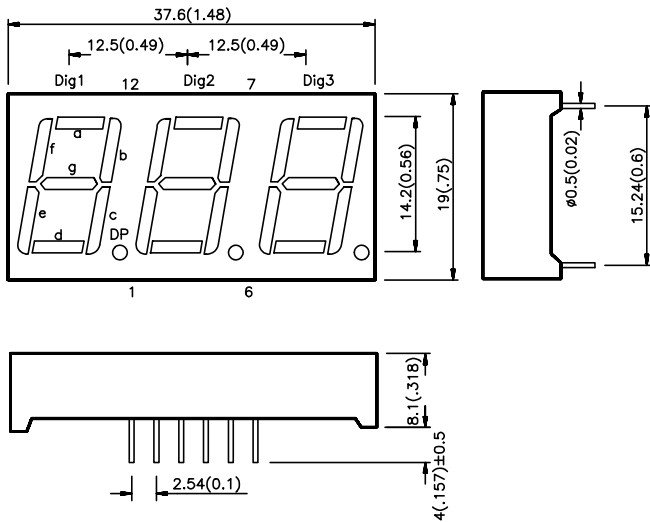

Internal Circuit Diagram

BA56-12

COMMON ANODE  
 Dig1 : 12  
 Dig2 : 9  
 Dig3 : 8

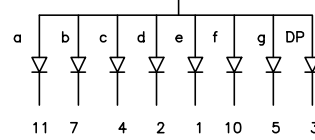

BC56-12

COMMON CATHODE  
 Dig1 : 12  
 Dig2 : 9  
 Dig3 : 8

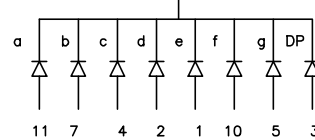

Notes:

1. All dimensions are in millimeters (inches). Tolerance is  $\pm 0.25(0.01)$  unless otherwise noted.
2. Specifications are subjected to change without notice.

Selection Guide

Part No.	Dice	Iv (ucd) @ 10 mA		Description
		Min.	Max.	
BA56-11HWA BA56-12HWA BA56-13HWA	BRIGHT RED (GaP)	900	2200	Common Anode, Rt. Hand Decimal
BC56-11HWA BC56-12HWA BC56-13HWA				Common Cathode, Rt. Hand Decimal
BA56-11EWA BA56-12EWA BA56-13EWA	HIGH EFFICIENCY RED (GaAsP/GaP)	2200	9000	Common Anode, Rt. Hand Decimal
BC56-11EWA BC56-12EWA BC56-13EWA				Common Cathode, Rt. Hand Decimal
BA56-11GWA BA56-12GWA BA56-13GWA	GREEN (GaP)	2200	5600	Common Anode, Rt. Hand Decimal
BC56-11GWA BC56-12GWA BC56-13GWA				Common Cathode, Rt. Hand Decimal
BA56-11YWA BA56-12YWA BA56-13YWA	YELLOW (GaAsP/GaP)	2200	5600	Common Anode, Rt. Hand Decimal
BC56-11YWA BC56-12YWA BC56-13YWA				Common Cathode, Rt. Hand Decimal
BA56-11SRWA BA56-12SRWA BA56-13SRWA	SUPER BRIGHT RED (GaAlAs)	5600	21000	Common Anode, Rt. Hand Decimal
BC56-11SRWA BC56-12SRWA BC56-13SRWA				Common Cathode, Rt. Hand Decimal

### Electrical / Optical Characteristics at T<sub>A</sub>=25°C

Symbol	Parameter	Device	Typ.	Max.	Units	Test Conditions
$\lambda_{peak}$	Peak Wavelength	Bright Red High Efficiency Red Green Yellow Super Bright Red	700 625 565 590 660		nm	IF=20mA
$\Delta\lambda_{1/2}$	Spectral Line Halfwidth	Bright Red High Efficiency Red Green Yellow Super Bright Red	45 45 30 35 20		nm	IF=20mA
C	Capacitance	Bright Red High Efficiency Red Green Yellow Super Bright Red	40 12 45 10 95		pF	VF=0V;f=1MHz
V <sub>F</sub>	Forward Voltage	Bright Red High Efficiency Red Green Yellow Super Bright Red	2.0 2.0 2.2 2.1 1.85	2.5 2.5 2.5 2.5 2.5	V	IF=20mA
I <sub>R</sub>	Reverse Current	All	10		uA	VR = 5V

### Absolute Maximum Ratings at T<sub>A</sub>=25°C

Parameter	Bright Red	High Efficiency Red	Green	Yellow	Super Bright Red	Units
Power dissipation	120	105	105	105	100	mW
DC Forward Current	25	30	25	30	30	mA
Peak Forward Current [1]	150	150	150	150	150	mA
Reverse Voltage	5	5	5	5	5	V
Operating/Storage Temperature	-40°C To +85°C					
Lead Soldering Temperature [2]	260°C For 5 Seconds					

Notes:

- 1/10 Duty Cycle, 0.1ms Pulse Width.
- 4mm below package base.

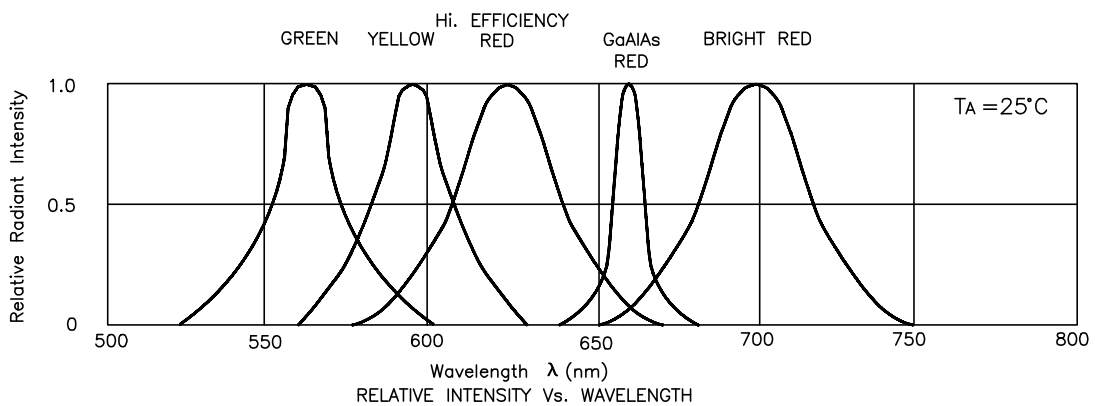

## Bright Red

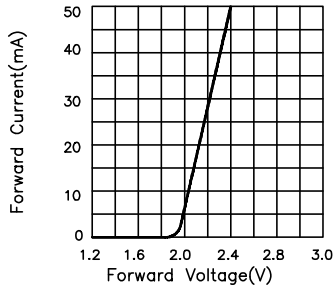

FORWARD CURRENT Vs. FORWARD VOLTAGE

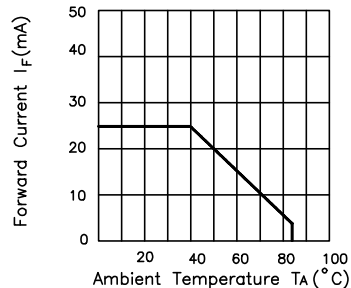

FORWARD CURRENT DERATING CURVE

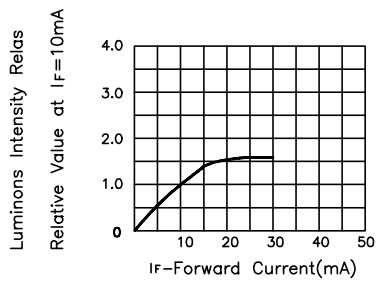

LUMINOUS INTENSITY Vs. FORWARD CURRENT

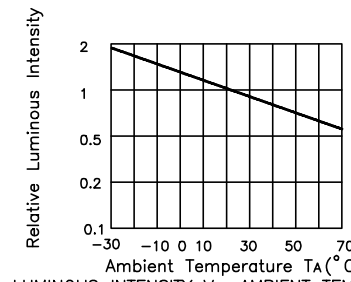

LUMINOUS INTENSITY Vs. AMBIENT TEMPERATURE

## High Efficiency Red

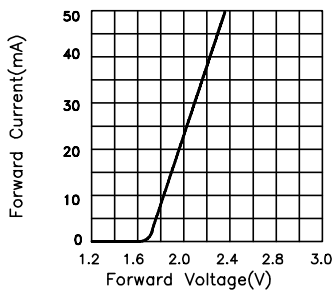

FORWARD CURRENT Vs. FORWARD VOLTAGE

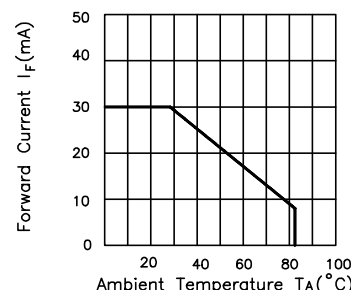

FORWARD CURRENT DERATING CURVE

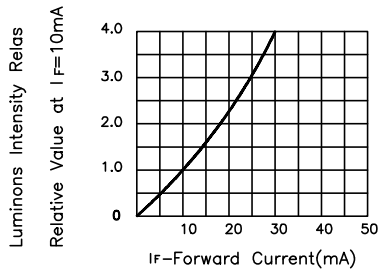

LUMINOUS INTENSITY Vs. FORWARD CURRENT

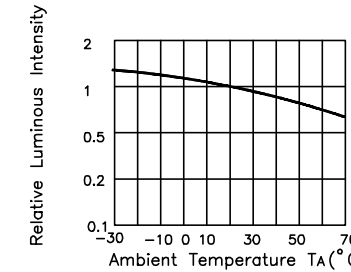

LUMINOUS INTENSITY Vs. AMBIENT TEMPERATURE

Green

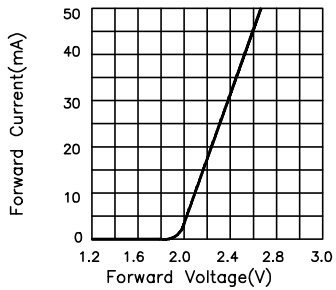

FORWARD CURRENT Vs. FORWARD VOLTAGE

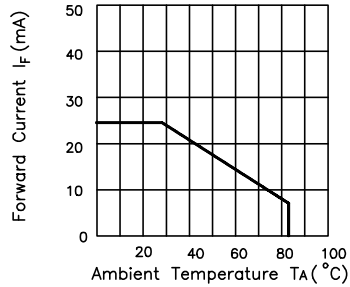

FORWARD CURRENT DERATING CURVE

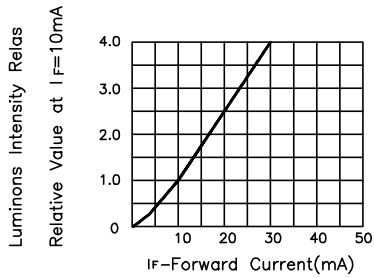

LUMINOUS INTENSITY Vs. FORWARD CURRENT

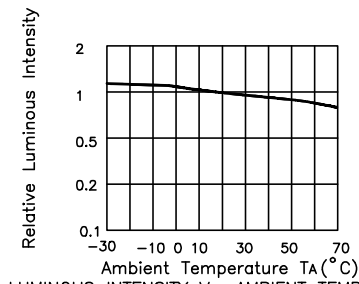

LUMINOUS INTENSITY Vs. AMBIENT TEMPERATURE

Yellow

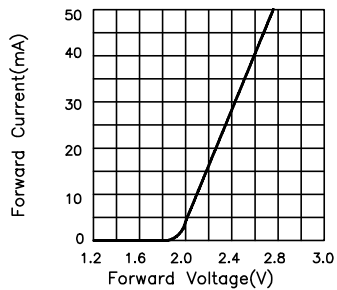

FORWARD CURRENT Vs. FORWARD VOLTAGE

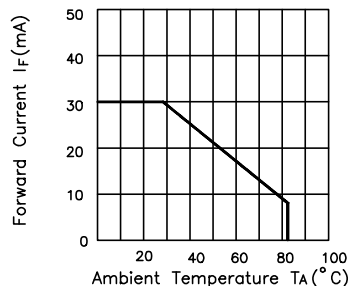

FORWARD CURRENT DERATING CURVE

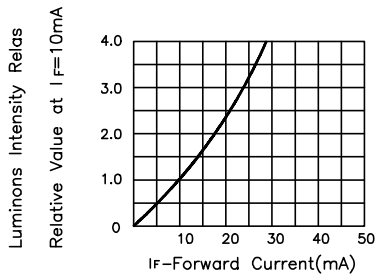

LUMINOUS INTENSITY Vs. FORWARD CURRENT

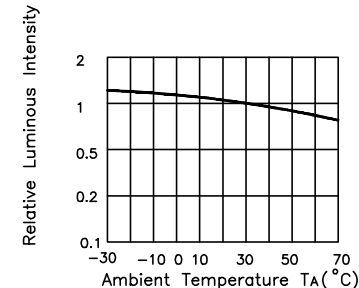

LUMINOUS INTENSITY Vs. AMBIENT TEMPERATURE

## Super Bright Red

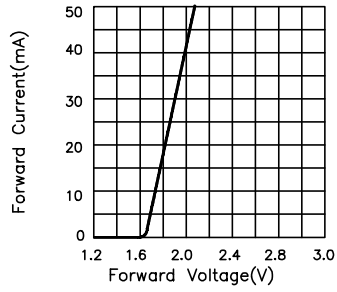

FORWARD CURRENT Vs. FORWARD VOLTAGE

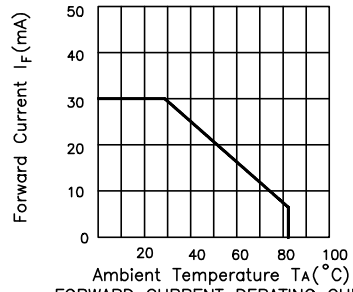

FORWARD CURRENT DERATING CURVE

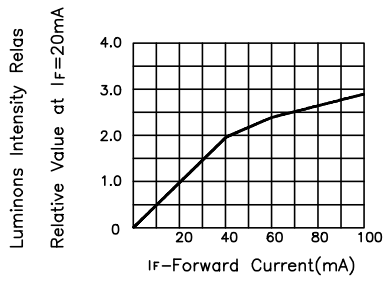

LUMINOUS INTENSITY Vs. FORWARD CURRENT

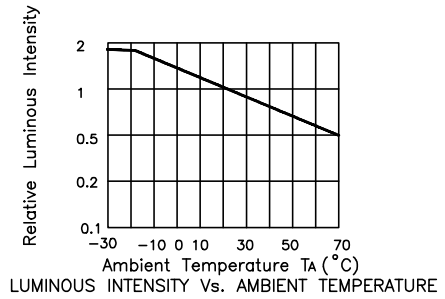

LUMINOUS INTENSITY Vs. AMBIENT TEMPERATURE