

END-LOOK PACKAGE LIGHT EMITTING DIODE

● Features:

1. High radiant power and high radiant intensity.
2. Standard T-1 package.
3. Peak wavelength $\lambda_p=940\text{nm}$.
4. Good spectral matching to si-photodetector.
5. Radiant angle: 30°
6. Lens Appearance: Water Clear.
7. This product doesn't contain restriction substance, comply ROHS standard

● Applications:

1. Remote Control.
2. Automatic Control System.

● Package Dimensions:

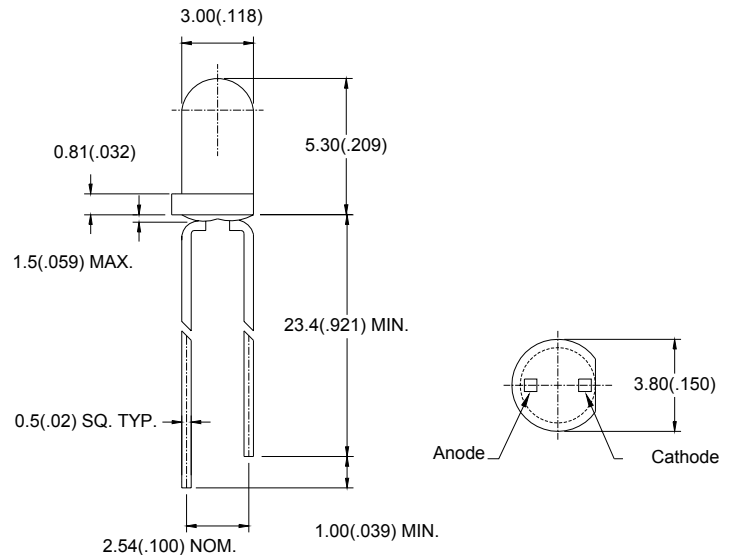

NOTES:

1. All dimensions are in millimeters (inches).
2. Tolerance is $\pm 0.25\text{mm}$ (0.01') unless otherwise specified.
3. Lead spacing is measured where the leads emerge from the package.
4. Specifications are subject to change without notice.

● Absolute Maximum Ratings($T_a=25^\circ\text{C}$)

Parameter	Symbol	Rating	Unit
Power Dissipation	P_d	100	mW
Continuous Forward Current	I_F	100	mA
Peak Forward Current ^{*1}	I_{FP}	1.0	A
Reverse Voltage	V_R	5	V
Operating Temperature	T_{opr}	$-45^\circ\text{C} \sim 85^\circ\text{C}$	-
Storage Temperature	T_{stg}	$-45^\circ\text{C} \sim 100^\circ\text{C}$	-
Soldering Temperature	T_{sol}	260°C (for 5 seconds)	-

^{*1} Condition for is I_{FP} pulse of 1/10 duty and 0.1 msec width.

● **Optical- Electrical Characteristics (@ $T_A=25^{\circ}C$)**

Parameter	Symbol	Test Conditions	Min	TYP	Max	Unit
Radiant Intensity	I_e	$I_F=50mA$	11.78	33.4	-	mW/sr
Forward Voltage	V_F	$I_F=50mA$	-	1.25	1.50	V
Reverse Current	I_R	$V_R=5V$	-	-	100	μA
Peak Wavelength	λ_p	$I_F=20mA$	-	940	-	nm
Spectral Line Half- Width	$\Delta \lambda$	$I_F=20mA$	-	50	-	nm
Viewing Angle	$2\theta_{1/2}$	$I_F=20mA$	-	30	-	deg

● **Typical Optical-Electrical Characteristic Curves**

Fig.1 Spectral Distribution

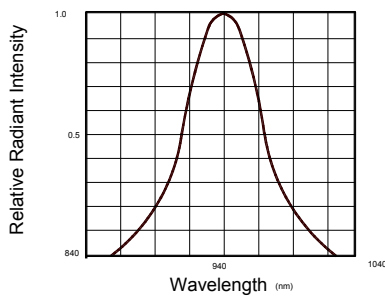

Fig.2 Forward Current Vs Ambient Temperature

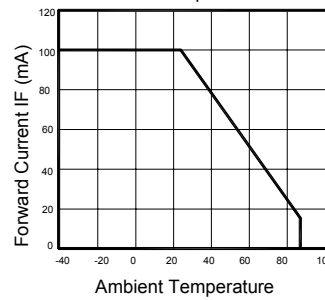

Fig.3 Forward Current Vs

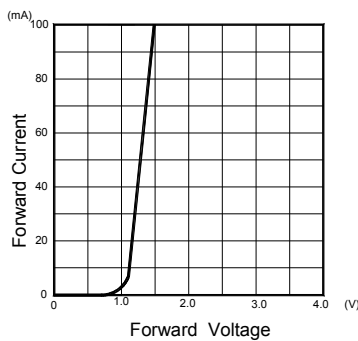

Fig.4 Relative Radiant Intensity Vs Ambient Temperature

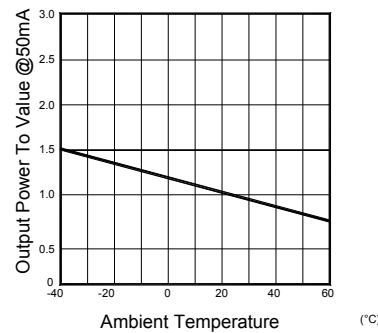

Fig.5 Relative Radiant Intensity Vs Forward Current

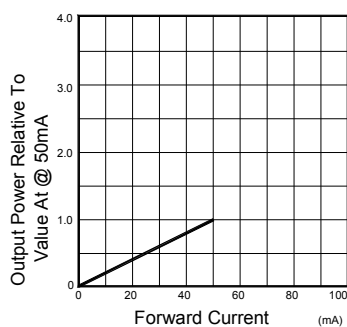
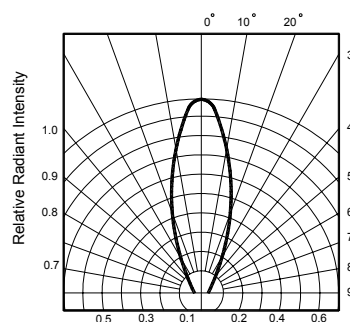
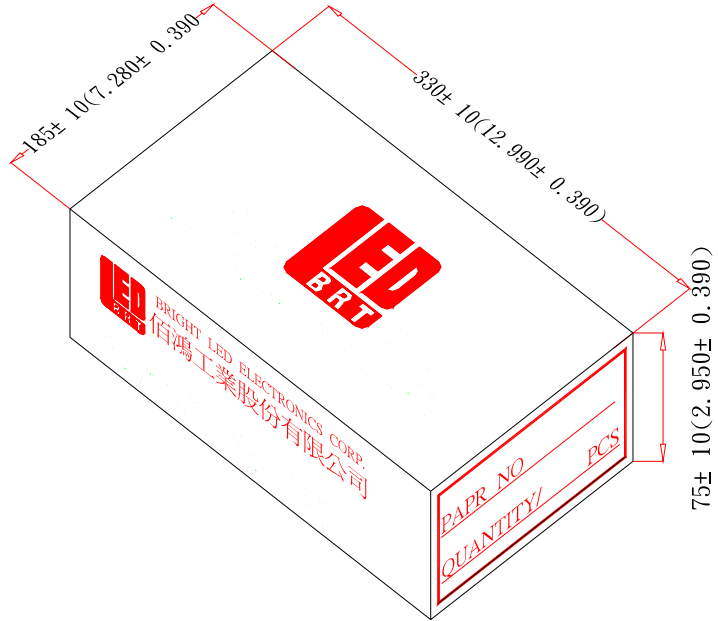

FIG.6 Radiant Diagram



● Tapping and packaging specifications(Units: mm)



● Packaging Bag Dimensions

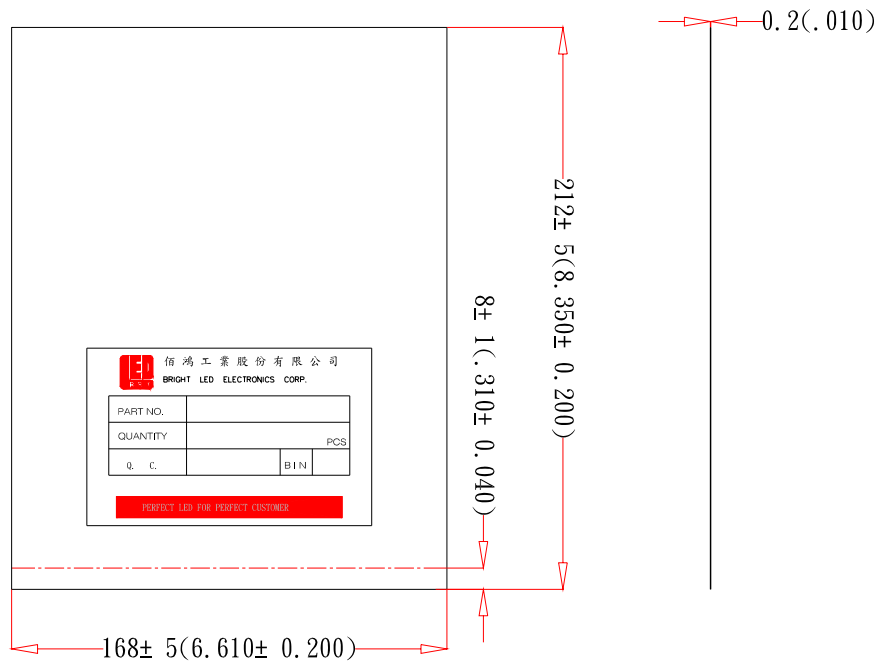

Notes:

- 1、1000pcs per bag, 8Kpcs per box.
- 2、All dimensions are in millimeters(inches).
- 3、Specifications are subject to change without notice.