

Specifications

Nominal Voltage		2 V
Capacity (25°C)	10HR(1.80V)	200 Ah
	3HR(1.75V)	153Ah
	1HR(1.60V)	120Ah
Dimension	Length	172±2mm (6.74inch)
	Width	110±2mm (4.34inch)
	Height	330±2mm (13.00inch)
	Total Height	364±2mm (14.3inch)
Approx. Weight		12.8kg (28.22lbs)±3%
Terminal type		T10
Internal resistance (Fully charged, 25°C)		Approx. 0.95mΩ
Capacity affected by temperature (10HR)	40°C	103%
	25°C	100%
	0°C	88%
	-15°C	70%
Self-discharge (25°C)	3 month	Remaining Capacity: 94%
	6 month	Remaining Capacity: 88%
	12 month	Remaining Capacity: 75%
Nominal operating temperature		25°C±3°C(77°F±5°F)
Operating temperature range	Discharge	-15°C~55°C(5°F~131°F)
	Charge	-10°C~55°C(14°F~131°F)
	Storage	-20°C~55°C(-4°F~131°F)
Float charging voltage(25°C)		2.25 to 2.30V Temperature compensation: -3mV/°C
Cyclic charging voltage(25°C)		2.35 to 2.40V Temperature compensation: -5mV/°C
Maximum charging current		40A
Terminal material		Copper
Maximum discharge current		1000A(5 sec.)
Designed floating life(20°C)		20 years

- ♦ Gelled electrolyte technology;
- ♦ PVC separator;
- ♦ Recognized by CE;
- ♦ ABS container.

Constant Current Discharge Characteristics (A, 25°C)

F.V/TIME	30min	60min	2h	3h	4h	5h	6h	8h	10h	20h	48h	120h
1.60V	170	120	73.0	52.0	41.8	36.4	31.2	24.4	20.4	10.7	---	---
1.65V	167	118	72.6	51.8	41.6	36.0	31.0	24.4	20.4	10.7	--	--
1.70V	163	115	72.0	51.4	41.2	35.8	30.8	24.2	20.2	10.6	4.88	---
1.75V	160	113	71.0	51.0	41.0	35.6	30.6	24.0	20.2	10.6	4.88	2.02
1.80V	155	109	69.2	49.4	39.8	34.6	29.6	23.2	20.0	10.5	4.84	2.00

Constant Power Discharge Characteristics (Watt, 25°C)

F.V/TIME	30min	60min	2h	3h	4h	5h	6h	8h	10h	20h	48h	120h
1.60V	318	228	141	102	82.0	71.6	61.4	48.8	40.6	21.4	---	---
1.65V	312	224	140	101	81.4	71.2	61.2	48.4	40.4	21.4	--	--
1.70V	306	218	139	100	81.0	70.6	60.8	48.0	40.4	21.2	9.94	---
1.75V	300	214	136	100	80.4	70.2	60.2	47.8	40.0	21.2	9.84	4.12
1.80V	290	208	133	97	78.0	68.0	58.4	46.4	39.8	21.0	9.78	4.10

Note: The above characteristics data can be obtained within three charge/discharge cycles.



Dimensions

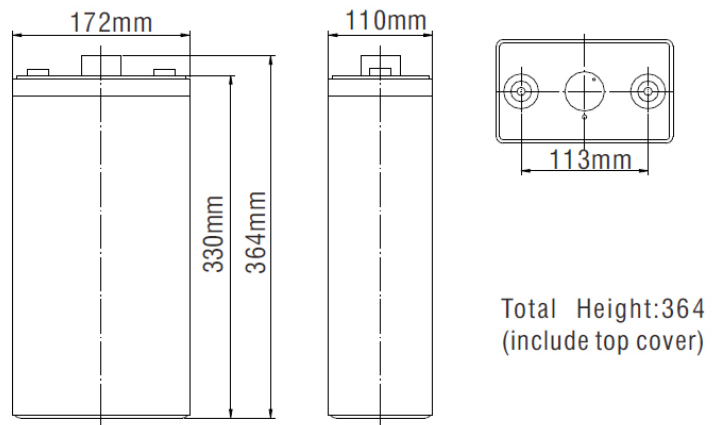

Terminal

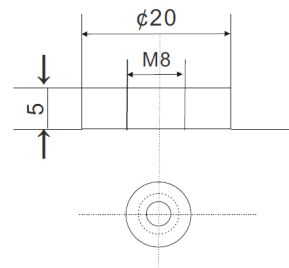

Discharge Characteristics(25°C)

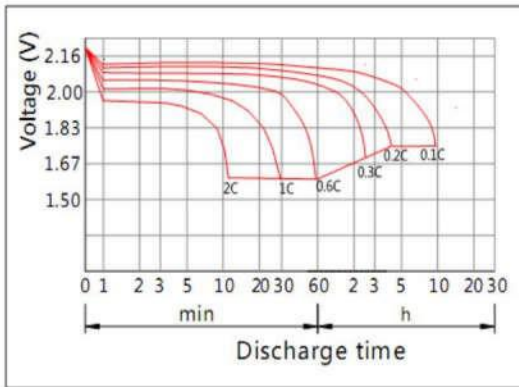

Charging Characteristics(25°C)

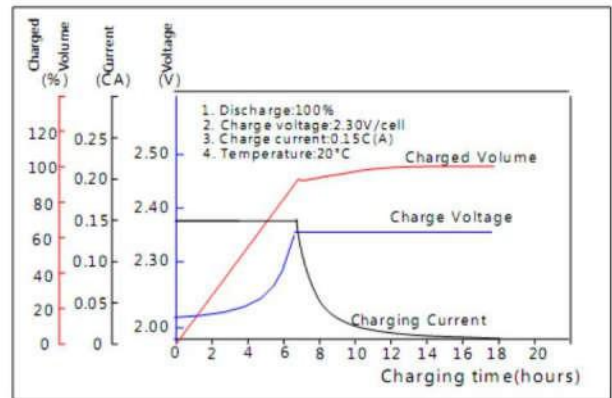

Effect of Temperature on Capacity

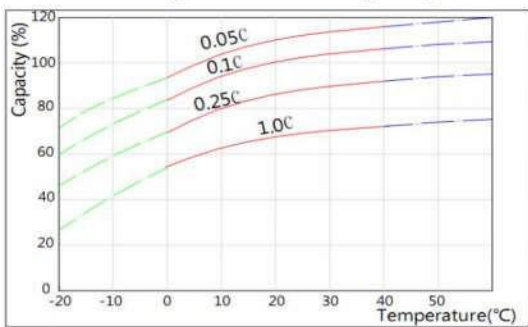

Self-discharge Characteristics

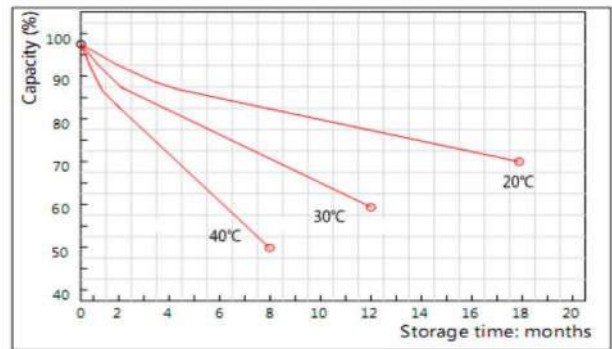

The Relationship for Open Circuit Voltage and Residual Capacity (25°C)

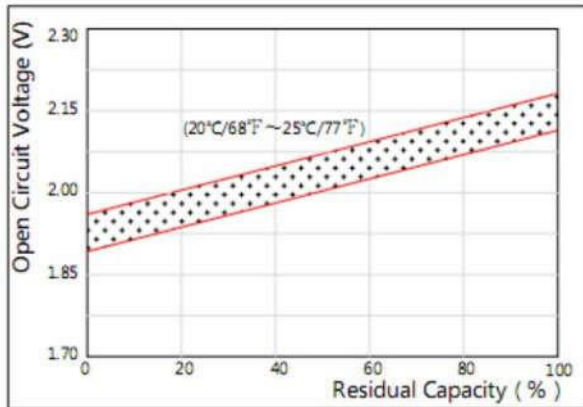

The Relationship for Charging Voltage and Temperature

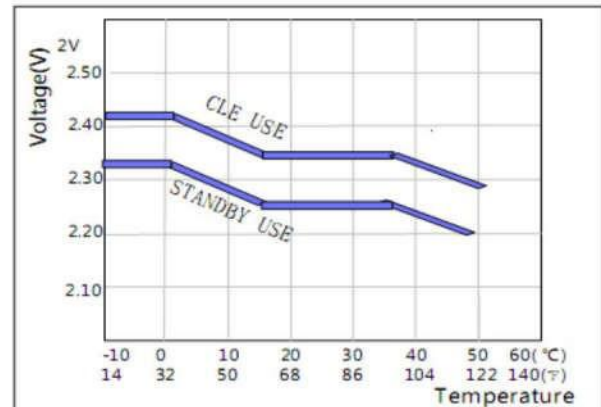

Floating Life on Temperature

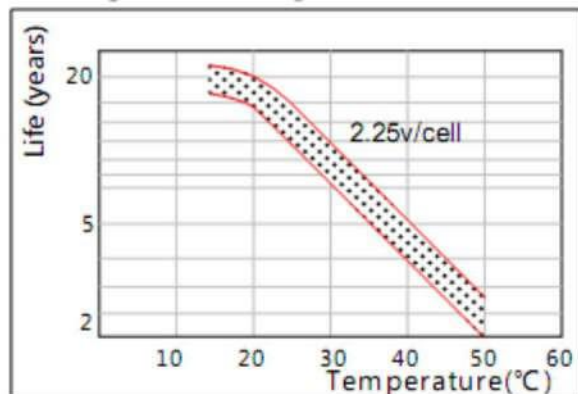

Cycle Life on D.O.D(25°C)

