

GND-5221Ax-Bx (DUAL DIGIT LED DISPLAY)

GND-5221 Series

GND-5221Ax

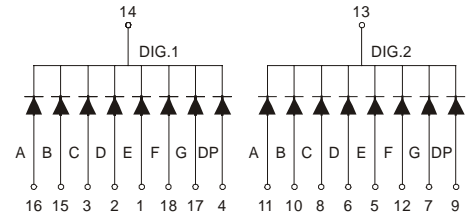
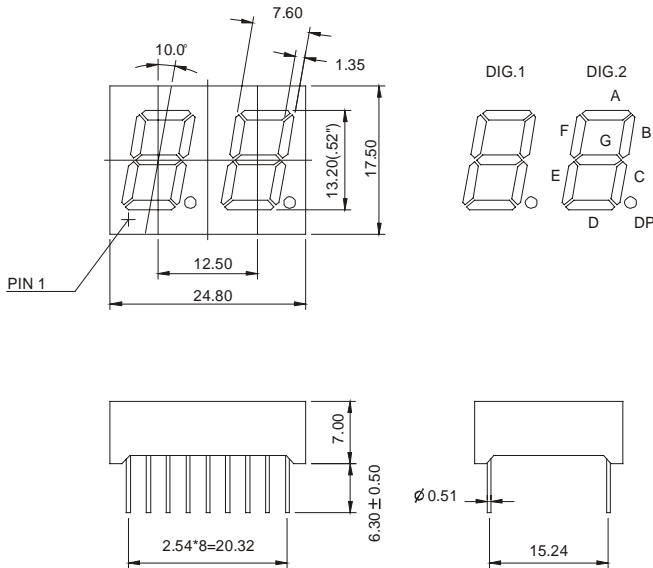

GND-5221Bx

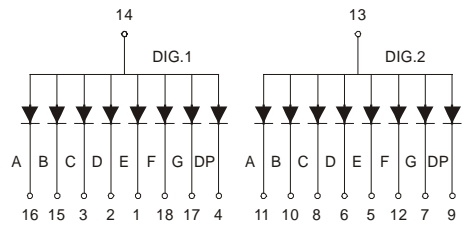

Features:

*0.52 INCH HIGH CHARACTER.

*EXCELLENT CHARACTER APPEARANCE.

*COMMON CATHODE OR COMMON ANODE.

*I.C. COMPATIBLE.

*LOW POWER CONSUMPTION.

Part Number	EMITTED COLOR		Common Cathode or Common Anode	Peak Wavelength (nm)	Vf (v) Typ	If (mA)	Intensity Per Segment (mcd)	
							Min.	Typ.
GND-5221AE	GaAsP/GaP	Hi.effi Red	Common Cathode	635	2.0	20	9	12
GND-5221AG	GaP	Green		565	2.1	20	8	11
GND-5221AY	GaAsP/GaP	Yellow		585	2.0	20	9	12
GND-5221AS	GaAlAs	Super Red		660	1.8	20	10	13
GND-5221AD	GaAlAs	Ultra Red		660	1.8	20	25	30
GND-5221AUE	AlGaInP	Ultra Red		625	2.0	20	30	35
GND-5221AUY	AlGaInP	Ultra Yellow		590	2.0	20	30	35
GND-5221BE	GaAsP/GaP	Hi.effi Red	Common Anode	635	2.0	20	9	12
GND-5221BG	GaP	Green		565	2.1	20	8	11
GND-5221BY	GaAsP/GaP	Yellow		585	2.0	20	9	12
GND-5221BS	GaAlAs	Super Red		660	1.8	20	10	13
GND-5221BD	GaAlAs	Ultra Red		660	1.8	20	25	30
GND-5221BUE	AlGaInP	Ultra Red		625	2.0	20	30	35
GND-5221BUY	AlGaInP	Ultra Yellow		590	2.0	20	30	35