



**Guangzhou Huiyou Technology Co., Ltd.**

No. 106, fengze east road, Nansha district,  
Guangzhou, Guangdong, China

文件编号: P015  
版本: 0  
制定日期: 2020.08.20

## 承认书

### SPECIFICATION FOR APPROVAL

客户名称

CUSTOMER \_\_\_\_\_

品名

PART NAME

Super Capacitor

客户料号

Customer Part No: \_\_\_\_\_

承认规格

APPROVE ITEM

4.2V 50F

供应商料号

Part Number \_\_\_\_\_

日期

DATE

2024.1.30

客户承认

Customer approval

供应商承认

Supplier admit that

Guangzhou Huiyou Technology Co., Ltd.

## 1. 适用范围 Scope

此规格书对产品的性能，测试方法进行了规范，作为技术确认的依据。

As a basis for technical confirmation, this sheet specifies the performance and test methods of the product .

## 2. 产品特性 Features

- ★ 工作电压高 High rated voltage
- ★ 体积小、质量轻 Small size and light
- ★ 长循环寿命 Long cycle life
- ★ 绿色环保 Green(RoHS compliant)
- ★ 安全可靠 Safe and reliable

## 3. 应用领域 Applications

- ★ 消费电子 Consumer electronics
- ★ 物联网 Internet of things
- ★ 智能仪表 Intelligent instruments
- ★ 玩具 Toys
- ★ UPS
- ★ 程控交换机 SPC exchange
- ★ 汽车记录仪 Vehicle traveling data recorder

## 4. 命名规则 Designation

<u>HLIC</u>	<u>4R2</u>	<u>N</u>	<u>506</u>	<u>DX</u>	<u>R</u>	<u>0825</u>
产品系列 Product series	额定电压(V) Rated Voltage	容量偏差(%) Tolerance	额定容量(F) Rated Capacitance	引出端形式 Terminal Structure	模组壳体结构 Module shell Structure	尺寸 Size
锂离子电容器 lithium-ion capacitor	4.2V	-20% ~ +80%	50F	导针吸塑盒装 Pins, blister box	塑料热缩 Plastic shrink-wrapping	8*25

## 5. 标准测试条件 Test Conditions

环境温度 Ambient temperature : 15°C ~ 35°C

湿度 Humidity : 25%RH ~ 75%RH

气压 Pressure : 86kPa~106kPa

\*电容量、内阻和漏电流尤其受温度的影响很大，如对结果有疑问，应按以下条件进行测量：

The capacitance, internal resistance and leakage current are particularly affected by temperature.

If in doubt about results, make measurements under the following conditions:

环境温度 Ambient temperature : 25°C±2°C

湿度 Humidity : 63%RH ~ 65%RH

气压 Pressure : 86kPa~106kPa

## 6. 性能参数 Parameters

电气性能 Electrical Performance		
容量 Capacitance	额定容量, Rated Capacitance, F	50
	容量偏差, Capacitance Tolerance, %	-20% ~ +80%
电压 Voltage	额定电压, Rated Voltage, V.DC	4.2V
内阻 Internal Resistance	内阻, internal resistance, RAC(1kHz,3.8V)	≤200mΩ
	DCR直流内阻,DCR DC internal resistance 3.8V@25±3°C, 10msec	≤400mΩ
电流 Current	1C测试电流, 1C test current, mA	18
	最大放电电流 Maximum Discharge Current, mA	200
	连续最大放电脉冲 (1sec), A	5.0
	漏电流 Leakage current @25°C@72h, μA	≤4.0
	最大充电电压/电流 Maximum charging voltage/ current, A	4.0V/0.4A
温度湿度 Temperature and humidity		
区间 Range	存储温度范围, Temperature for Storage, °C	10 ~ +55
	存储湿度范围, Humidity for Storage, RH	≤60%RH
寿命 Life		
温度特性 Temperature characteristics	Test conditions at -20°C, +25°C, +65°C	
	容量变化 (初始值衰减) Capacitance change (decrease from initial value)	(-20°C) : 30% of the initial measurement value; (+65°C) : 30% of the initial measurement value
	内阻变化 (初始值增大) Internal Resistance (increase from initial value)	(-20°C): ≤10 times of the initial specified value; (+65°C): ≤2 times of the initial specified value
循环寿命 Cycle Life	Under normal temperature conditions, charge the cell to 3.7V at a current value of 15mA, and then discharge it to 3.1V at this current. (100000 times)	
	容量变化 (初始值衰减) Capacitance Change (decrease from initial value)	≤ 30%
	内阻变化 (初始值增大) Internal Resistance (increase from initial value)	≤ 4倍 (times)
高温高湿存储特性 High temperature and high humidity storage characteristics	Under normal temperature conditions, charge the monomer to 3.8V at 1C current and constant voltage for 1 hour, and then store it at 60±2°C and 90±2% RH for 1000h.	
	容量变化 (初始值衰减) Capacitance Change (decrease from initial value)	≤ 30%
	内阻变化 (初始值增大) Internal Resistance (increase from initial value)	≤ 2倍 (times)
高温浮充 High temperature float charging	Place the product at 55±2°C, charge the monomer to 3.8V at 155mA, and then stabilize the voltage under this condition for 1000h.	
	容量变化 (初始值衰减) Capacitance Change (decrease from initial value)	≤ 30%
	内阻变化 (初始值增大) Internal Resistance (increase from initial value)	≤ 4倍 (times)

## 7. 外形尺寸(单位: mm) Dimensions (Units : mm)

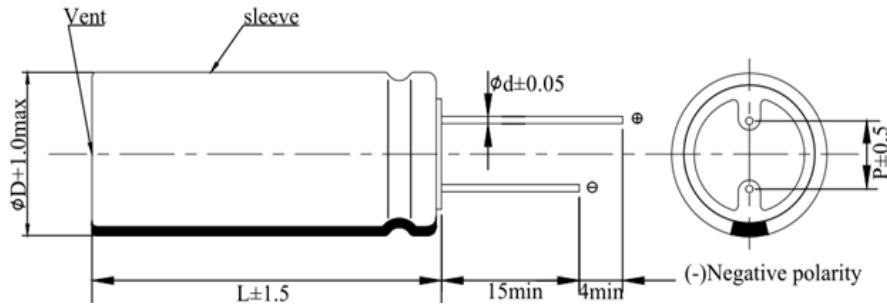

厚度 (D±1.0)	高度 (L±2.0)	脚距 (P±0.5)	CP线 (φd±0.05)
8	25	3.5	0.6

## 8. 产品测试方法 Testing method

### 8.1 额定容量 Rated Capacitance (IEC, F) :

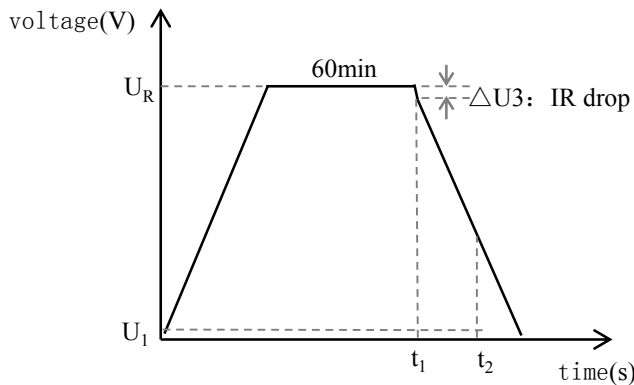

容量计算方式 Capacitance calculation :  $C = I \times \frac{t_2 - t_1}{U_1 - U_2}$

I : 放电电流 , discharging current :  $4 \times C_R \times U_R$  (mA)

U<sub>1</sub> : 计算的初始电压 , calculation start voltage :  $0.8 \times U_R$  (V)

U<sub>2</sub> : 计算的结束电压 , calculation end voltage :  $0.4 \times U_R$  (V)

t<sub>1</sub> : 放电开始到电压U<sub>1</sub> 的时间, the time from the start of discharge to reach U<sub>1</sub>, (s)

t<sub>2</sub> : 放电开始到电压U<sub>2</sub> 的时间, the time from the start of discharge to reach U<sub>2</sub>, (s)

### 8.2 交流内阻 AC ESR ( Ω ) :

测量电路 : Measurement circuit:

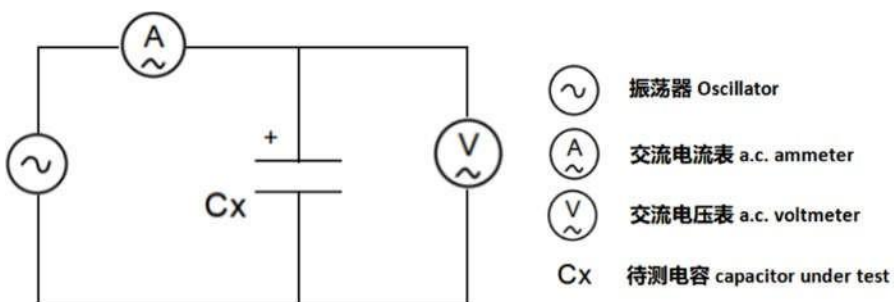

内阻计算公式：ESR calculation :  $R_{\text{EC}} = \frac{U}{I}$

U : 交流电压有效值 , AC voltage rms, (V r.m.s)

I : 交流电流有效值 , AC current rms, (A r.m.s)

测量电压的频率, Measurement frequency of the voltage should be : 1 kHz;

交流电流应为, The AC current should be : 1mA ~ 10mA

### 8.3 最大持续电流 Maximum Continuous Current :

最大持续工作电流 (  $\Delta T=15^{\circ}\text{C}$  ) : Maximum continuous working current within  $15^{\circ}\text{C}$  of

temperature change (A) :  $I_{\text{CC}} = \sqrt{\frac{\Delta T}{\text{ESR}_{\text{DC}} * R_{\text{th}}}}$

### 8.4 最大峰值电流 Maximum Peak Current :

一秒钟放电至一半额定电压的最大放电电流 ( A ) : Maximum current needed to discharged

from rated voltage to half rated voltage in 1 second (A) :  $I_{\text{max}} = \frac{\frac{1}{2}U_R}{\text{ESR}_{\text{DC}} + \frac{1}{C}}$

### 8.5 能量与功率 Energy and Power :

最大储存能量 Maximum stored energy ( Wh ) :  $E_{\text{max}} = \frac{\frac{1}{2} \times C \times U_R^2}{3600}$

能量密度 Specific Energy ( Wh/kg ) :  $E_{\text{d}} = \frac{\frac{1}{2} \times C \times U_R^2}{3600 \times \text{mass}}$

功率密度 Usable Specific Power ( W/kg ) :  $P_{\text{d}} = \frac{0.12 \times U_R^2}{\text{ESR}_{\text{DC}} \times \text{mass}}$

## 9. 注意事项 Cautions

下述注意事项需严格遵守。对于没有按照以下注意事项所造成的任何意外事故，广州汇优科技有限公司不负任何责任。

The warnings should be followed seriously, otherwise Guangzhou Huiyou Technology Co., Ltd. is not responsible for any loss caused by misconduct.







## 注意事项

- 锂离子电容器的使用温度不宜超过额定温度上限或下限。
- 锂离子电容器不可处于相对湿度为85%以上或含有有毒气体的场所，该种环境下引线及壳体易受潮及腐蚀，导致锂离子电容器断路
- 锂离子电容器若需长期储存，请在温度10~55℃，相对湿度60%以下，通风良好的场所存放，严禁暴晒。

## Cautions

- The operating temperature of lithium-ion capacitors should not exceed the upper or lower rated temperature limit.
- Lithium-ion capacitors should not be placed in places where the relative humidity is above 85% or where toxic gases are contained. In such an environment, the leads and shell are susceptible to moisture and corrosion, causing the lithium-ion capacitor to open circuit.
- If lithium ion capacitors need to be stored for a long time, please store them in a well-ventilated place with a temperature of 10~55°C and a relative humidity of less than 60%. Exposure to the sun is strictly prohibited.

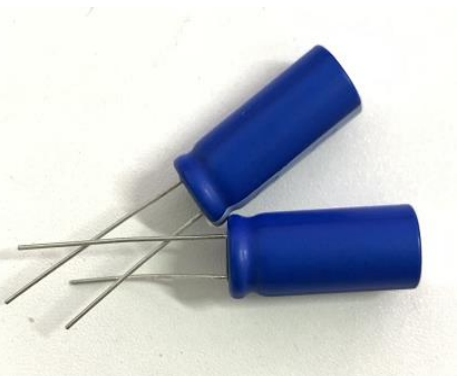
### 常见的使用过程产品短路情形 Common short circuit situations in process products

Short circuit occurred during measurement	Short circuit occurred during product handling
 ×	 ×
Products placed together causing leads to contact	Short circuit occurs
 ×	 ×

如有任何关于超级电容器的问题，请与我们联系。

Please contact with us if you have any question on our products.