

RB151 ...RB157; W005 ...W10; W005M ...W10M

1.5A SINGLE - PHASE SILICON BRIDGE

Features

- Surge overload rating - 50 amperes peak
- Ideal for printed circuit boards
- Reliable low cost construction utilizing molded plastic technique results in inexpensive product
- Mounting Position: Any

VOLTAGE RANGE
50 to 1000 Volts
CURRENT
1.5 Amperes

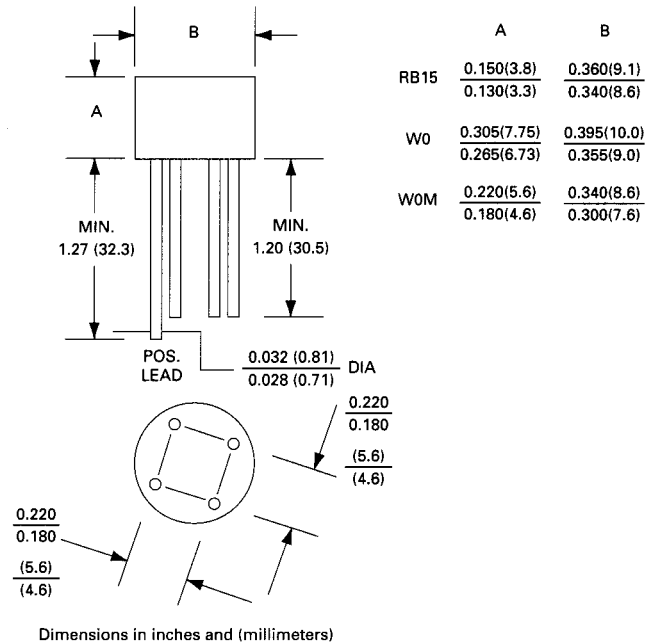

MAXIMUM RATINGS AND ELECTRICAL CHARACTERISTICS

Rating at 25 °C ambient temperature unless otherwise specified
Single-phase, half-wave, 60 Hz, resistive or inductive load.
For capacitive load, derate current by 20%.

| | RB151 | RB152 | RB153 | RB154 | RB155 | RB156 | RB157 | |
|---|--------------|-------|-------|-------|-------|-------|-------|------------------|
| | W005 | W01 | W02 | W04 | W06 | W08 | W10 | |
| | W005M | W01M | W02M | W04M | W06M | W08M | W10M | UNITS |
| Maximum Recurrent Peak Reverse Voltage | 50 | 100 | 200 | 400 | 600 | 800 | 1000 | V |
| Maximum RMS Voltage | 35 | 70 | 140 | 280 | 420 | 560 | 700 | V |
| Maximum DC Blocking Voltage | 50 | 100 | 200 | 400 | 600 | 800 | 1000 | V |
| Maximum Average Forward Rectified Current $T_A = 25\text{ }^\circ\text{C}$ | 1.5 | | | | | | | A |
| Peak Forward Surge Current, 8.3 ms single half sine-wave superimposed on rated load | 50.0 | | | | | | | A |
| 1 st Rating for fusing ($t < 8.35\text{ms}$) | 5.0 | | | | | | | A ^{2t} |
| Maximum Forward Voltage drop per element at 1.0A Peak | 1.0 | | | | | | | V |
| Maximum Reverse Current at rated $T_A = 25\text{ }^\circ\text{C}$ | 10.0 | | | | | | | μA |
| Operating Temperature Range T_J | -55 to + 125 | | | | | | | $^\circ\text{C}$ |
| Storage Temperature Range T_A | -55 to + 150 | | | | | | | $^\circ\text{C}$ |

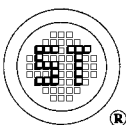

SEMTECH ELECTRONICS LTD.

(wholly owned subsidiary of HONEY TECHNOLOGY LTD.)



RB151 ...RB157; W005 ...W10; W005M ...W10M

1.5A SINGLE - PHASE SILICON BRIDGE

RATING AND CHARACTERISTICS CURVES

RB151 RB157
 W005 THRU W10
 W005M W10M

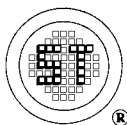
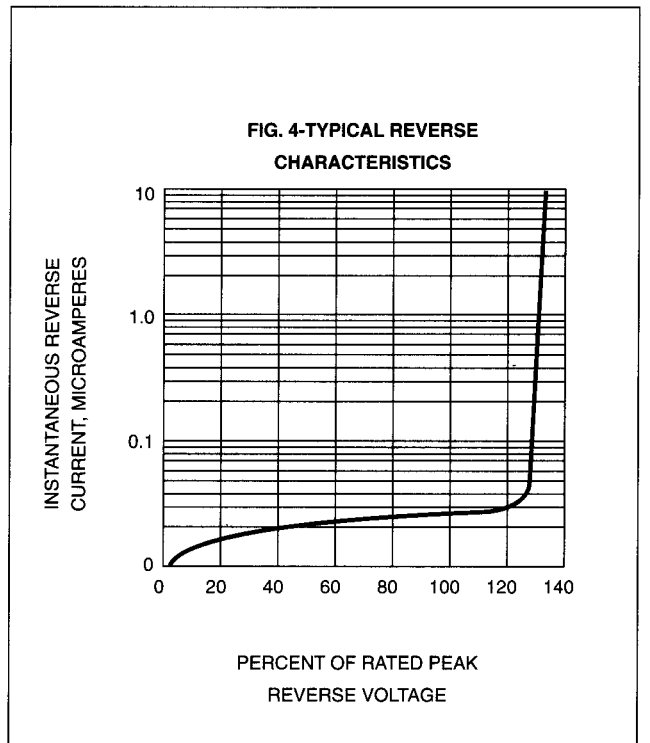
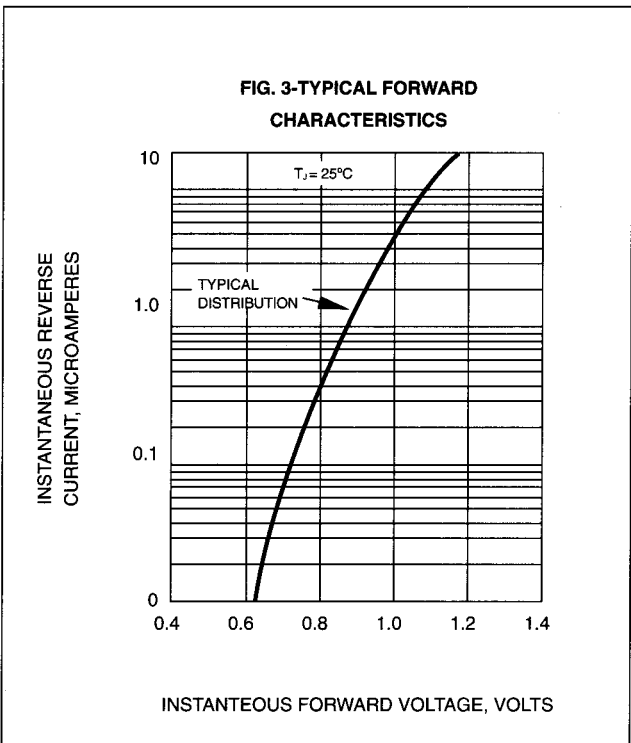
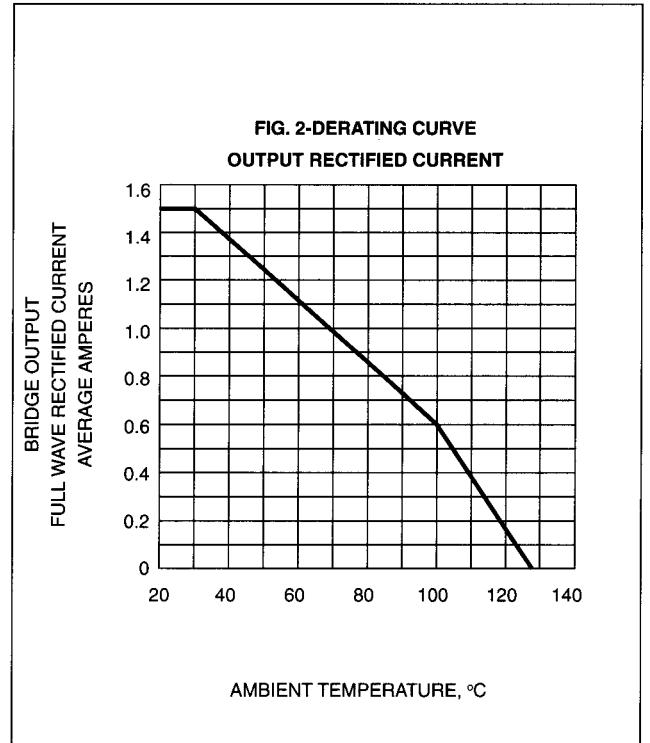
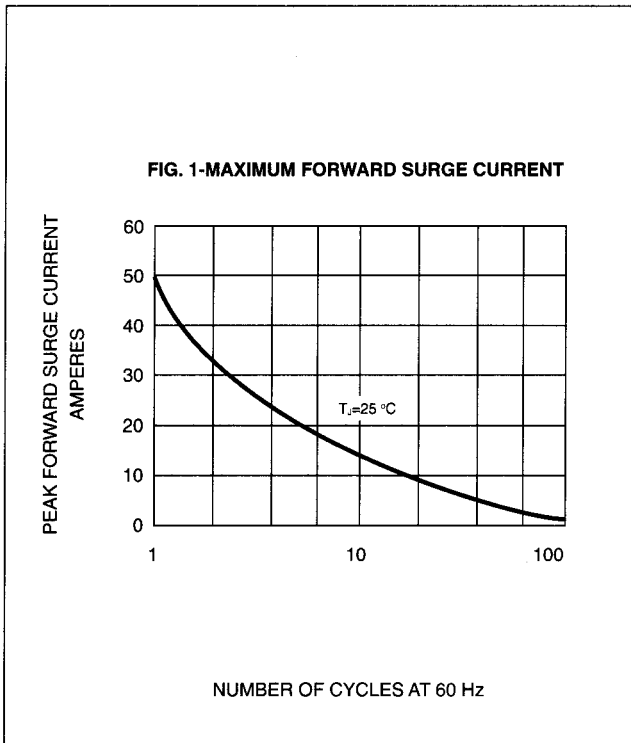

SEMTECH ELECTRONICS LTD.
 (wholly owned subsidiary of HONEY TECHNOLOGY LTD.)

