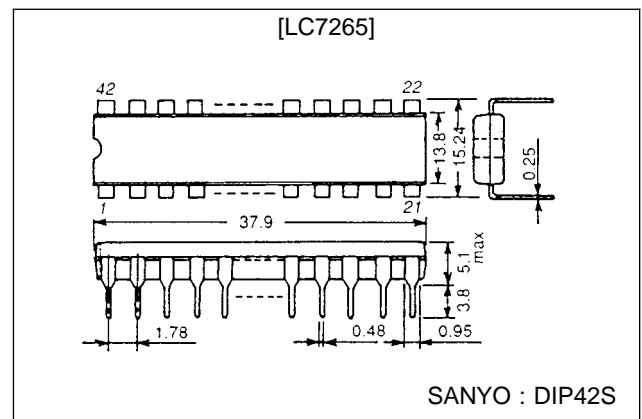

SANYO**LC7265****Received Frequency Display for Radio Receivers****Features**

- Displays received frequency of each band of FM, MW, LW (LED static display).
- Counts local oscillation frequency and displays received frequency.
- Number of display digits : FM-5 digits, MW-4 digits, LW-3 digits.
- Covers intermediate frequencies shown below.
 - FM : +10.700, +10.725, +10.750, +10.675 MHz
-10.700, -10.725, -10.675, -10.650 MHz
 - MW, LW : +450 kHz : 10 kHz step display
+450 kHz : 1 kHz step display
+455 kHz : 1 kHz step display
+469 kHz : 1 kHz step display
- Contains blanking circuit to turn off display.
- Contains hold circuit to hold display contents.
- Uses crystal resonator having 7.2 MHz reference frequency.
- Uses LB3500 (+8 prescaler) jointly at the time of FM reception.
- Supply voltage V_{DD} : 4.5 V to 10 V

Package Dimensions

unit : mm

3025B-DIP42S**Specifications****Absolute Maximum Ratings at $T_a = 25^\circ\text{C}$, $V_{SS} = 0\text{ V}$**

Parameter	Symbol	Conditions	Ratings	Unit
Maximum supply voltage	$V_{DD\text{ max}}$		-0.3 to +11	V
Input voltage	V_{IN}	All input pins	-0.3 to $V_{DD}+0.3$	V
Output voltage	V_{O1}	X_{OUT} , \overline{HLD} , 50 Hz, output: off	-0.3 to $V_{DD}+0.3$	V
	V_{O2}	Output pins other than V_{O1}	0 to 15	V
Allowable power dissipation	$P_d\text{ max}$	$T_a \leq 65^\circ\text{C}$	550	mW
Allowable power dissipation of segment outputs	$P_d\text{ (seg)1}$	MHz, $\overline{b\&c}$, $\overline{b\&e}$, $V_{DD} = 4.5$ to 6.5 V , $I_{OL} = 33\text{ mA}$	30	mW
	$P_d\text{ (seg) 2}$	Other outputs, $V_{DD} = 4.5$ to 6.5 V , $I_{OL} = 16.5\text{ mA}$	15	mW
	$P_d\text{ (seg) 3}$	MHz, $\overline{b\&c}$, $\overline{b\&e}$, $V_{DD} = 6.0$ to 10 V , $I_{OL} = 36\text{ mA}$	25	mW
	$P_d\text{ (seg) 4}$	Other outputs, $V_{DD} = 6.0$ to 10 V , $I_{OL} = 18\text{ mA}$	12	mW
Operating temperature	T_{opr}		-30 to +65	$^\circ\text{C}$
Storage temperature	T_{stg}		-40 to +125	$^\circ\text{C}$

SANYO Electric Co., Ltd. Semiconductor Business Headquarters

TOKYO OFFICE Tokyo Bldg., 1-10, 1 Chome, Ueno, Taito-ku, TOKYO, 110-8534 JAPAN

63098HA(II)/6088YT/9105KI/3173KI/D162KI/7162KI/6242KI, TS No.1197-1/6

LC7265

Allowable Operating Ranges at Ta = 25 °C, V_{DD} = 4.5 to 10 V, V_{SS} = 0 V

Parameter	Symbol	Conditions	min	typ	max	Unit
Supply voltage	V _{DD}		4.5		10	V
Input high-level voltage	V _{IH1}	$\overline{A/F}$, \overline{BLK}	0.7V _{DD}		V _{DD}	V
	V _{IH2}	FIF1, FIF2, FIF3, AIF1, AIF2	0.9V _{DD}		V _{DD}	V
Input low-level voltage	V _{IL1}	$\overline{A/F}$, \overline{BLK}	0		0.3V _{DD}	V
	V _{IL2}	FIF1, FIF2, FIF3, AIF1, AIF2	0		0.1V _{DD}	V
Input frequency	f _{IN1}	FMI, sine wave, capacitive coupling, V _{IN1} = 0.7V _{p-p}	1		18	MHz
	f _{IN2}	AMI, sine wave, capacitive coupling, V _{IN2} = 0.5V _{p-p} *	0.5		3	MHz
	f _{IN3}	X _{IN}	0.2		7.5	MHz
Input amplitude	V _{IN1}	FMI, sine wave, capacitive coupling, f _{IN1} = 1 to 18 MHz	0.7		0.9V _{DD}	V _{p-p}
	V _{IN2}	AMI, sine wave, capacitive coupling, f _{IN2} = 0.5 to 3 MHz	0.5*		0.9V _{DD}	V _{p-p}
	V _{IN3}	X _{IN} , sine wave, capacitive coupling, f _{IN3} = 0.2 to 7.5 MHz	1.0		0.9V _{DD}	V _{p-p}
Segment current	I _{seg1}	MHz, b&e, b&c	0		30	mA
	I _{seg2}	Other outputs	0		15	mA

*: For f_{IN2} = 0.5 MHz to 0.9 MHz and V_{DD} = 8 to 10 V, V_{IN2} min = 1.0 V_{p-p} applies.

Electrical Characteristics at Ta = 25 °C, V_{DD} = 4.5 to 10 V, V_{SS} = 0 V

Parameter	Symbol	Conditions	min	typ	max	Unit
Input high-level current	I _{IH1}	FIF1, FIF2, FIF3, AIF1, AIF2 V _I = V _{DD}	0		10	μA
	I _{IH2}	\overline{BLK} V _I = V _{DD}	0		2	μA
Input low-level current	I _{IL1}	FIF1, FIF2, FIF3, AIF1, AIF2 V _I = V _{SS}	0		10	μA
	I _{IL2}	\overline{BLK} V _I = V _{SS}	0		2	μA
	I _{IL3}	$\overline{A/F}$ V _I = V _{SS}	20		500	μA
Input floating voltage	V _{IF}	$\overline{A/F}$ V _I = open	0.8V _{DD}		V _{DD}	V
Input/output high-level leakage current	I _{OFF}	\overline{HLD} , output off, V _I = V _{DD}	0		2	μA
Output low-level voltage	V _{OL1}	\overline{HLD} , output on, I _O = 1 mA	0		1	V
	V _{OL2}	b&e, b&c, MHz V _{DD} = 4.5 to 10 V, I _{OL} = 30 mA	0		0.7	V
	V _{OL3}	Segments other than above V _{DD} = 4.5 to 10 V, I _{OL} = 15 mA	0		0.7	V
	V _{OL4}	50 Hz, I _O = 0.2 mA	0		1.0	V
Input high-level threshold voltage	V _{th}	\overline{HLD}	0.4V _{DD}	0.5V _{DD}	0.7V _{DD}	V
Output off leakage current	I _{OFF2}	All segments output pins, V _O = 13 V, output off	0		10	μA
Current drain	I _{DD}	FM mode, $\overline{A/F}$ = open or V _{DD} , f _{IN1} = 18 MHz, 0.7V _{p-p} or (AM mode, $\overline{A/F}$ = V _{SS} , f _{IN2} = 3 MHz, 0.5V _{p-p}) f _{IN3} = 7.2 MHz, 1V _{p-p} FIF1, FIF2, FIF3 = V _{DD} AIF1, AIF2 = V _{DD} \overline{HLD} , \overline{BLK} = V _{DD} other pins open	0		18	mA

Pin Assignment

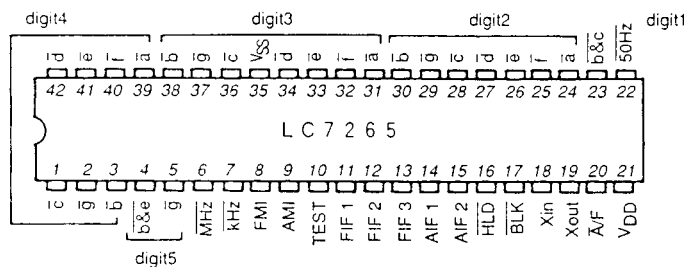

Top view

Equivalent Circuit Block Diagram

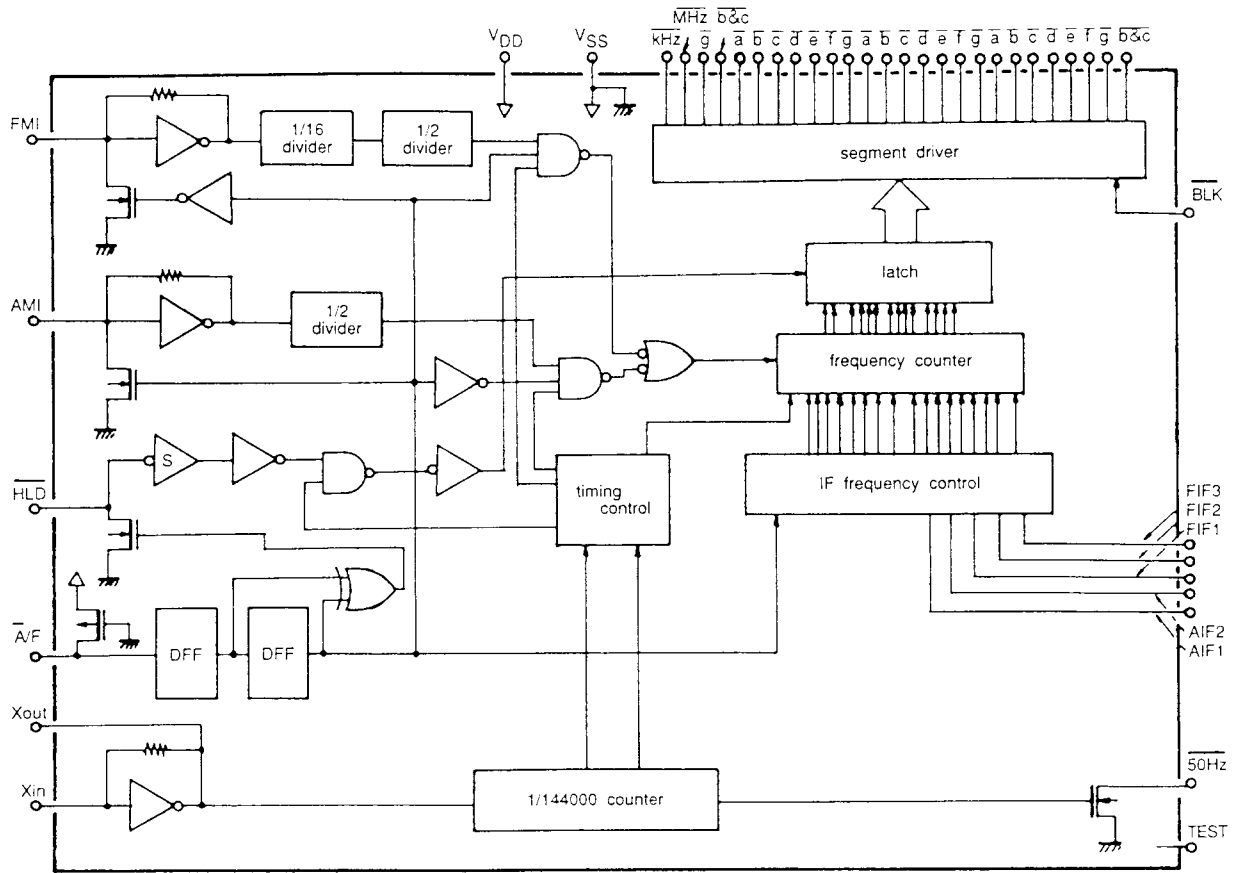

1. Display

1-1 Display font

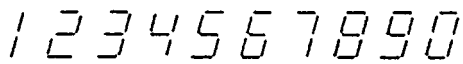

1-2 Lighting system

- Static lighting

1-3 Display range (High-order 1 digit : zero blanking)

- FM : 00.00 MHz to 199.95 MHz 50 kHz step
- MW, LW : 000 kHz to 1999 kHz 10 kHz or 1 kHz step

2. Pin Description

2-1 • \bar{a} to \bar{g} , $\bar{b\&c}$, $\bar{b\&e}$, \overline{MHz} , \overline{kHz} : LED

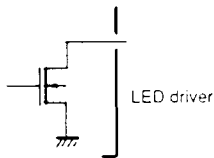

2-2 • V_{DD} , V_{SS} : Power supply pins

2-3 • X_{IN} , X_{OUT} : Crystal resonator or input amp pin

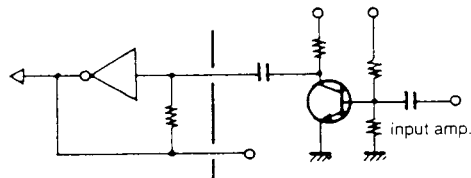
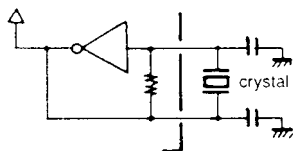

LC7265

2-4 • FIF1, FIF2, FIF3 : FM IF select pins

FIF1	0	0	0	0	1	1	1	1
FIF2	0	0	1	1	0	0	1	1
FIF3	0	1	0	1	0	1	0	1
IF (MHz)	+10.700	+10.725	+10.675	+10.750	-10.700	-10.725	-10.675	-10.650

2-5 • AIF1, AIF2 : AM IF select pins

AIF1	0	0	1	1
AIF2	0	1	0	1
IF (kHz)	+450 (2)	+450 (1)	+455	+469

1 : High level (V_{DD})
0 : Low level (V_{SS})

(Note) 450 kHz(1) : 10 kHz step display, others : 1 kHz step display

2-6 • \overline{HLD} : Display contents hold pin

Normally, this pin is set at high level. To hold display contents, this pin is set at low level. Connecting time constant circuit to this pin makes it possible to hold display contents for a certain period of time at the time of FM/MW, LW band selection.

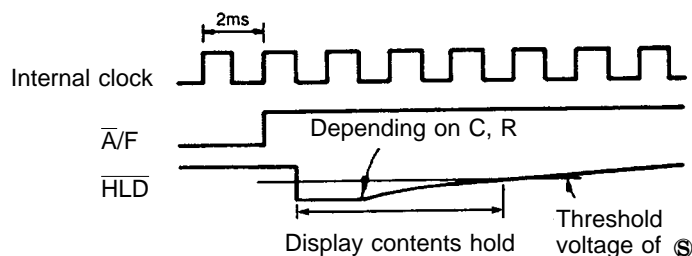
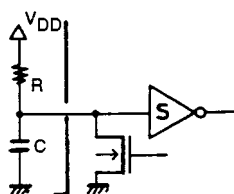

2-7 • \overline{BLK} : Display blanking pin

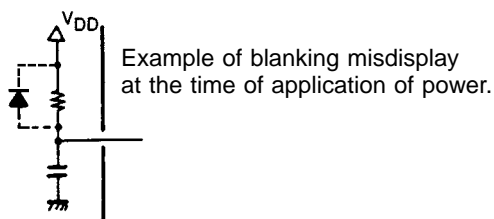

2-8 • FMI, AMI : Local oscillation signal input pins

FMI — For FM : 0.7Vp-p input sensitivity
AMI — For MW, LW : 1.0Vp-p input sensitivity ($V_{DD} = 8$ to 10 V, $f_{IN} = 0.5$ to 0.9 MHz)
0.5Vp-p input sensitivity (other than above)

2-9 • $\overline{A/F}$: FM/MW, LW select pin

FM — Pin open or high level
MW, LW — Low level

2-10 • $\overline{50\text{ Hz}}$: 50 Hz time base output pin

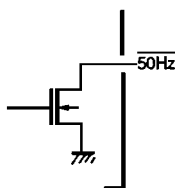

Hold time – time constant connected to $\overline{\text{HLD}}$ pin

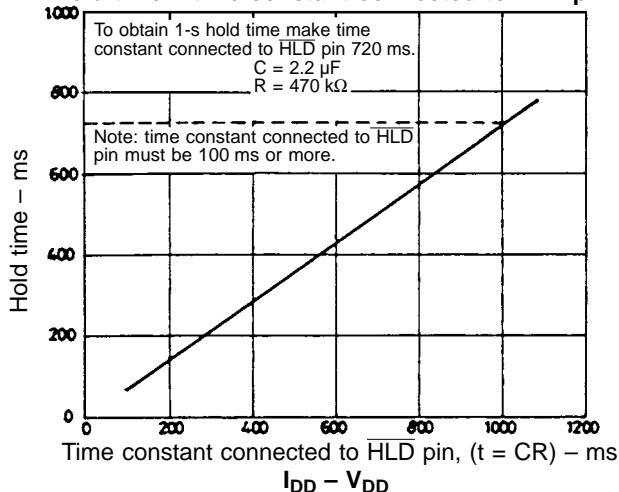

Time constant connected to $\overline{\text{BLK}}$ pin – V_{DD} rise time

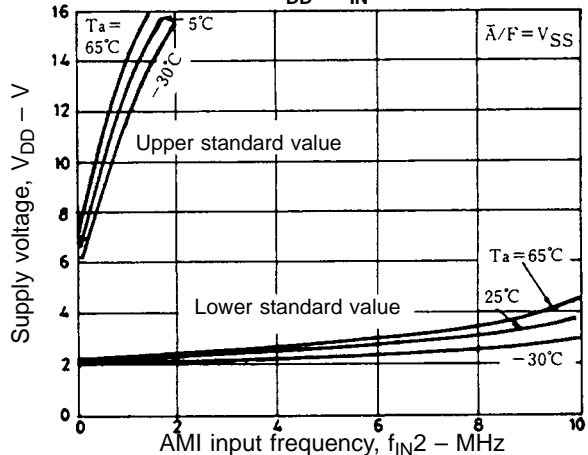
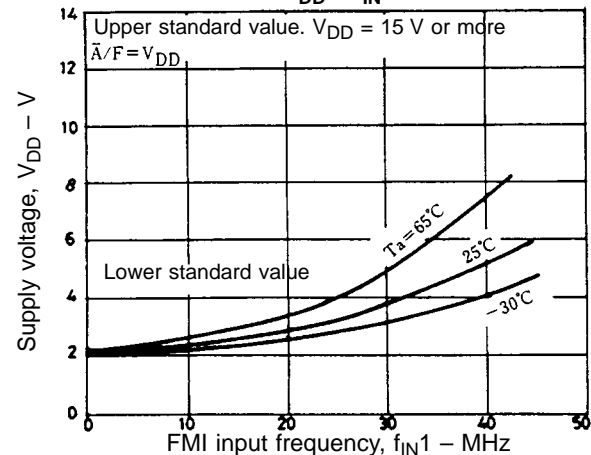
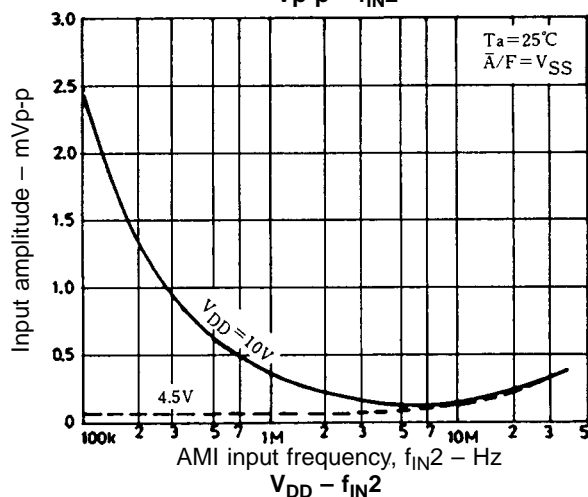
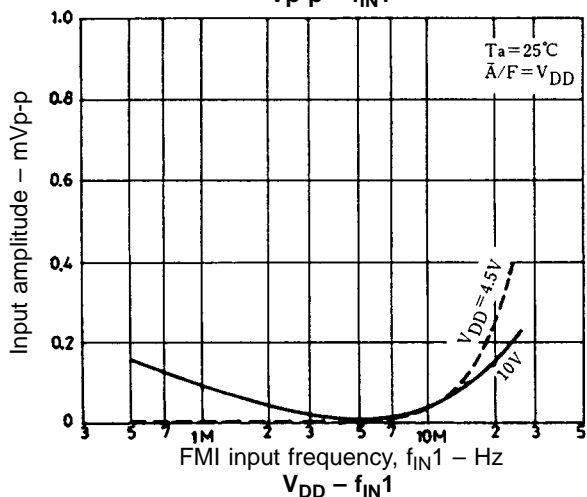
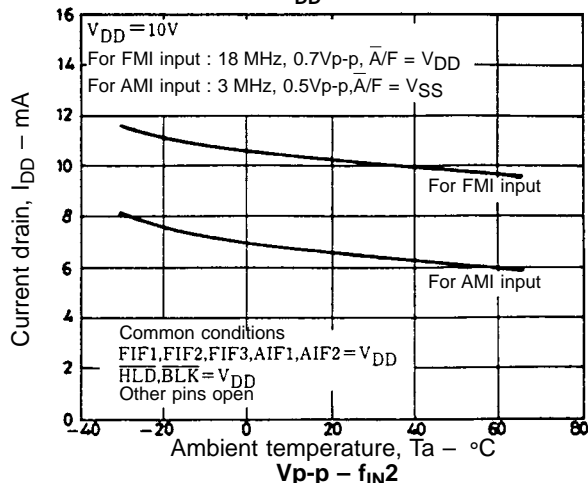
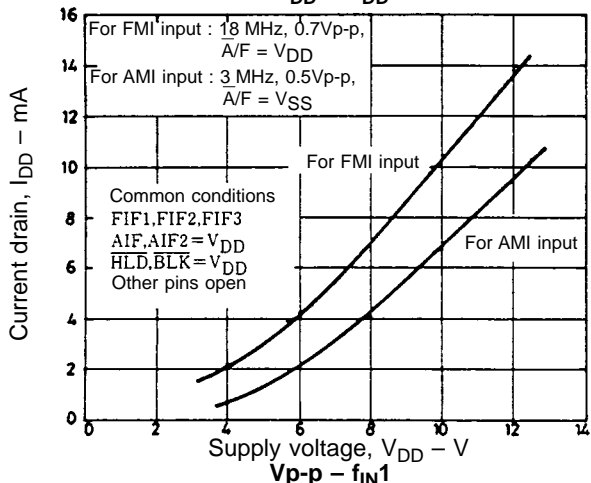
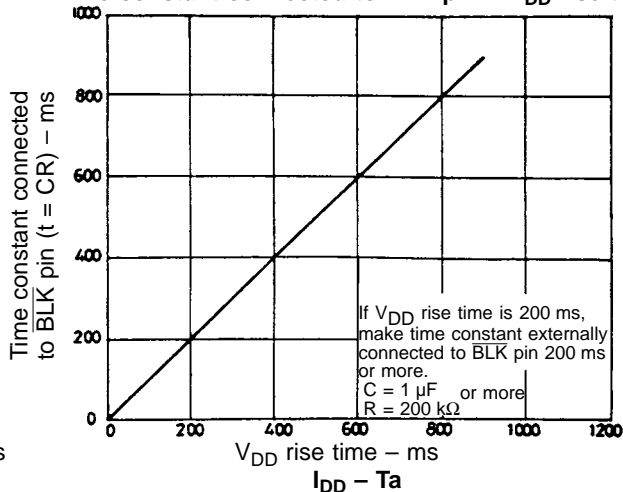

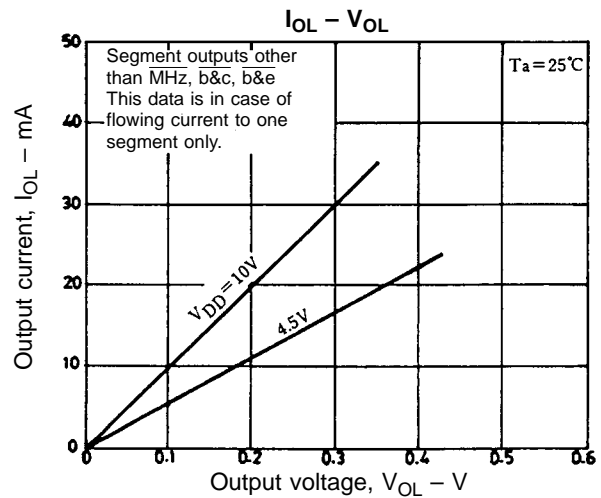
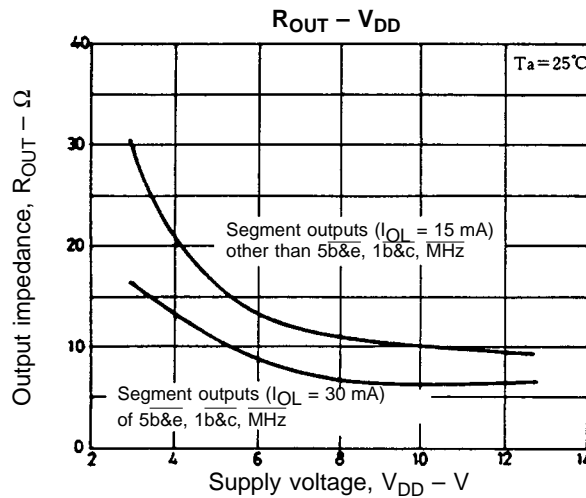
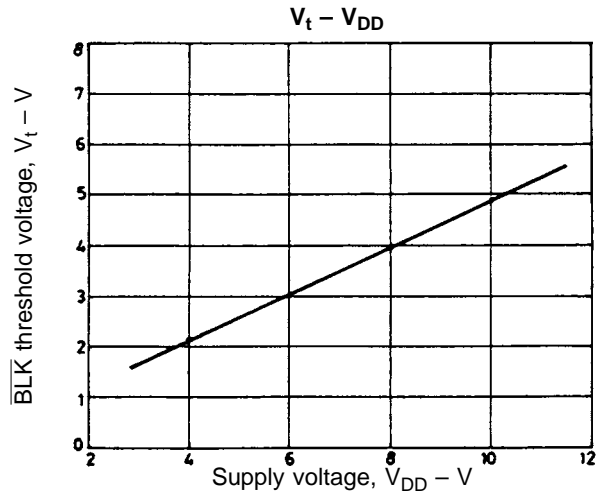
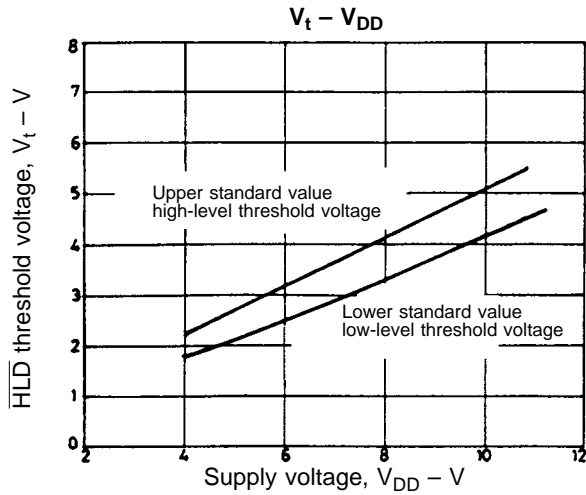

- No products described or contained herein are intended for use in surgical implants, life-support systems, aerospace equipment, nuclear power control systems, vehicles, disaster/crime-prevention equipment and the like, the failure of which may directly or indirectly cause injury, death or property loss.
- Anyone purchasing any products described or contained herein for an above-mentioned use shall:
 - ① Accept full responsibility and indemnify and defend SANYO ELECTRIC CO., LTD., its affiliates, subsidiaries and distributors and all their officers and employees, jointly and severally, against any and all claims and litigation and all damages, cost and expenses associated with such use:
 - ② Not impose any responsibility for any fault or negligence which may be cited in any such claim or litigation on SANYO ELECTRIC CO., LTD., its affiliates, subsidiaries and distributors or any of their officers and employees jointly or severally.
- Information (including circuit diagrams and circuit parameters) herein is for example only; it is not guaranteed for volume production. SANYO believes information herein is accurate and reliable, but no guarantees are made or implied regarding its use or any infringements of intellectual property rights or other rights of third parties.

This catalog provides information as of June, 1998. Specifications and information herein are subject to change without notice.

This datasheet has been download from:

www.datasheetcatalog.com

Datasheets for electronics components.